

Strengthening Primary Health Care System- Phase II
MPTF OFFICE GENERIC FINALPROGRAMME NARRATIVE REPORT
REPORTING PERIOD: FROM January 2009 TO December 2012

Programme Title & Project Number
<ul style="list-style-type: none"> Programme Title: Strengthening Primary Health Care-Phase II Programme Number: D2-25 MPTF Office Project Reference Number: 54904

Country, Locality(s), Priority Area(s) / Strategic Results
<i>Country/Region</i>
<i>Iraq- Nation wide</i>
<i>Priority area/ strategic results: Health and Nutrition Sector</i>

Participating Organization(s)
WHO (Lead agency) and UNICEF

Implementing Partners
(MOH, MOHE, MOF, MOPDC).

Programme/Project Cost (US\$)
Total approved budget as per project document: MPTF /JP Contribution ¹ : USD 11,918,000
<ul style="list-style-type: none"> WHO: USD 5, 930,368 UNICEF: USD 5, 987,632
Agency Contribution
<ul style="list-style-type: none"> WHO: USD 200,000
Government Contribution
For both WHO and UNICEF is USD 500,000
Other Contributions (donors)
TOTAL: USD 12,618,059

Programme Duration
Overall Duration (49 months)
Start Date 8 th of December 2008)
Original End Date (8 th December 2010)
Actual End date (31 st of December 2012)
Have agency(ies) operationally closed the Programme in its(their) system? Yes <input checked="" type="checkbox"/> No <input type="checkbox"/>
Expected Financial Closure date:
WHO: 30 th of June 2013
UNICEF: 31 of December 2012

Programme Assessment/Review/Mid-Term Eval.
Evaluation Completed
<input type="checkbox"/> Yes <input checked="" type="checkbox"/> No Date: dd.mm.yyyy
Evaluation Report - Attached
<input type="checkbox"/> Yes <input checked="" type="checkbox"/> No Date: dd.mm.yyyy

Report Submitted By
<ul style="list-style-type: none"> Name: Dr. Syed Jaffar Title: WHO Representative for Iraq Participating Organization (Lead): WHO and UNICEF Email address: wriraq@irq.emro.who.int

¹ The MPTF/JP Contribution is the amount transferred to the Participating UN Organizations – see [MPTF Office GATEWAY](#)

FINAL PROGRAMME REPORT FORMAT

EXECUTIVE SUMMARY

A. Background: During the last two decades, the health status of the Iraqi population deteriorated steadily and became among the poorest in the region, well below levels found in countries of comparable income. The proportion of women dying in child birth (maternal mortality ratio) currently stands at 84 per 100,000 live births,² placing Iraq in a group of 68 countries globally which account for 97% of all maternal and child deaths. The maternal mortality ratio is struggling to meet the target of 29 for every 100,000 live births. This is mainly the result of poor birth practices, inadequate referral or availability of emergency obstetric care, and a high level of anaemia among pregnant women (35%), which particularly affects rural women and those in the southern and central governorates.³ One in four delivering women faces serious complications during pregnancy.⁴ Approximately one in 15 adult female deaths can be attributed to maternal mortality.⁵ The proportion of births attended by skilled personnel has risen considerably from 50% in 1990 to 89% in 2006, meaning that the target of 100% by 2015 is realistically achievable.⁶ Improvements are particularly required in rural areas, where skilled personnel attend only 78% of births.⁷

The proportion of children dying within the first year of life has dropped from 50 to 35 for every 1,000 live births,⁸ but these infants account for 85% of deaths among children aged under five. Acute respiratory infection and diarrhoeal diseases are exacerbated by low birth weights and inadequate essential newborn care and feeding practices. Of the countries in the region, only Yemen has a higher infant mortality rate.⁹

The health care system in Iraq is now on transition from a hospital-oriented capital intensive, and inefficient model with inequitable access towards a system based on Primary Health Care in line with the Alma Ata Declaration. Currently various reform elements are being implemented to make the system providing better access and good quality services in an equitable and sustainable manner.

B. Strengthening Primary Health Care Phase I project (2004-2008).

As mentioned above the two decades of war, conflict, sanctions, and rigid authoritarian governance affected all sectors including health sector. According to the UN/World Bank Joint Needs Assessment (2003), in the wake of these sanctions, funding for healthcare was cut 90% resulting in the deterioration of healthcare facilities and quality of services due to lack of maintenance and supplies. Additionally, many of the nation's health professionals immigrated to other countries, leaving the MoH understaffed and resulting in reliance on under-trained healthcare providers. This assessment also indicated that a significant obstacle to restoring the Iraqi healthcare system was the centralized,

² WHO/COSIT/KRSO/MoH Iraq Family Health Survey 2006-2007

³ WHO/COSIT/KRSO/MoH Iraq Family Health Survey 2006-2007

⁴ World Bank/COSIT/KRSO Iraq Household Socio-Economic Survey 2007

⁵ WHO/MoH/COSIT/KRSO Iraq Family Health Survey 2006-2007

⁶ 1990 data from Department of Health and Vital Statistics; 2006 data from UNICEF/COSIT/KRSO/MoH Multiple Indicator Cluster Survey 2006

⁷ UNICEF/COSIT/KRSO/MoH Multiple Indicator Cluster Survey 2006

⁸ 1990 data from Maternal and Child Mortality Study 1990; 2006 data from UNICEF/COSIT/KRSO/MoH Multiple Indicator Cluster Survey 2006

⁹ mdgs.un.org

hospital-oriented healthcare framework. This system proved to be expensive and logistically problematic, resulting in a distribution of services that was both inefficient and provided inequitable access to low-income earners.

There was a need to increase the capacity of Iraqi healthcare and access to health services. In view of the mentioned situation WHO embarked on a project entitled Strengthening Primary Health Care System (SPHCS) Project Phase I.

The aim of the SPHCS project was to “facilitate the transition of the Iraqi healthcare delivery system from curative and hospital based, into a decentralized Primary Healthcare (PHC) based system, with a focus on community outreach and community involvement.” SPHCS was implemented during the period of July 2004-July 2008 at a national level in a total of 19 districts. It was funded by UNDG-ITF with a total budget of USD \$37,363,515. The targeted districts included: Tilkeif, Dakok, Beiji, Ba’aquba, Heet, Mahmoudia, Madaen, Swera, Amarah, Zubair, Suk Al Shyouk, Alurmaitha, Diwania, Manathera, Hindia, Al Musaiab, Akra, Shaklawa, Dukan.

The original start date was June 2004 with projected completion by December 2005. The duration of the project at approval was set for 18 months. The completion date was subsequently revised to March 2008. Total implementation delay was 27 months, with the duration extending to approximately 45 months.

The SPHCS project focused on the following objectives: 1.Establish 19 sustainable and functioning model PHC districts (including a functional referral system), with one district in each of the 18 governorates (two in Baghdad), which provide a BHSP to their population; 2. 2,000 trained health personnel at all levels; 3.A family physician and nurse practitioner model initiated; 4. Enhanced community participation in health activities.

SPHCS project implementation witnessed a complex and volatile security situation. The 2005-2007 time period was referred to as the most insecure period with high numbers of incidences of violence.

C. Strengthening Primary Health Care Phase II project (2009-2012)

In order to build on the achievements of SPHCS Phase I and to continue WHO support to the MoH, SPHCS Phase II was developed. The aim of Strengthening Primary Health Care System (SPHCS) phase II project is to support the MoH efforts in the area of Health Sector Reform and strengthening the decentralized District Primary Health Care (PHC) System in Iraq. This is in line with the Ministry of Health (MoH) articulated vision for PHC as 'an accessible, affordable, available, safe and comprehensive quality health service of the highest possible standard that is financially sound and founded on scientific principles in order to meet the present and future health needs of Iraqi people regardless of their ethnicity, geographic origin, gender or religious affiliation.' This vision calls for an integrated reform of the Health Care System which is the main objective of this project. This project is also in conformity with the MoH goal to transform inefficient, centrally-planned and curative care-based services into a new system based on prevention and evidence-based, equitable, high quality, accessible and affordable primary health care.

This project is a WHO-UNICEF joint project that builds on previous achievements under the Strengthening of Primary Health Care System (SPHCS) Phase I project in Iraq. The total funding for this nationwide 2years project is US\$ 11,918,000 with- \$5,987,632 share of UNICEF and \$5,930,368 as share of WHO. This project started in December of 2008 and will end in June of 2012.

The immediate objectives of phase II are to (a) invest in the national capacity of MoH/DoH staff in targeted areas to improve Integrated Health Services Delivery, including community psychosocial support (b) invest in improving the Human Resources Planning capacity for the MoH staff (c) strengthen the national capacity of National Health Information System (d) strengthen the National Health Care Financing System (e) strengthen the health governance and policy environment.

Output 1. Capacity of the MoH in targeted areas developed for improved Integrated Health Services Delivery.

The following achievements have been made in the following areas of strategic importance which will pave the way for the successful reform of health system based on the principles of PHC and will establish a successful model of health services delivery which will respond to the health care needs of Iraqi population in an effective and sustainable manner.

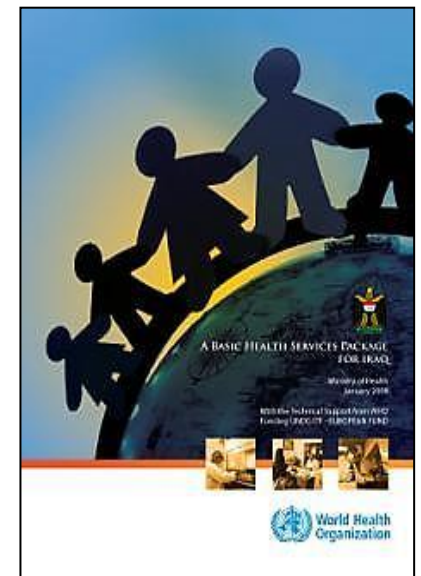

The Basic Health Services Package for Iraq (BHSP)

1.1 Development and Implementation of Basic Health Service Package (BHSP) through Integrated District Health System based on Family Practice Approach (IDHS-FPA).

The MoH with the technical and financial support of WHO developed the Basic Health Service Package (BHSP), the BHSP is defined as a minimum collection of essential health services that all population need to have a guaranteed access to.

The package was approved by the MoH in a formal session that was conducted in Baghdad in February 2010.H.E. the Minister of Health declared that this package will pave the way for a successful reform of the health care system and will establish the basic and essential milestone of a decentralized PHC system which is based on the principles of Alma-Ata Declaration.

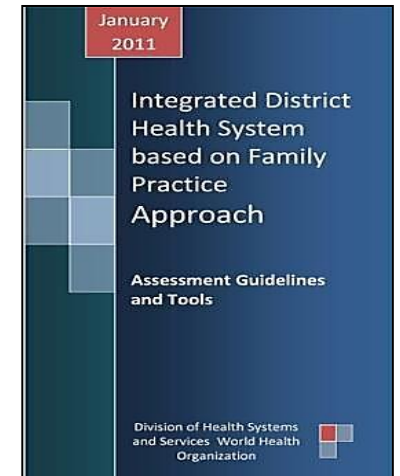

Assessment tools for Integrated District Health System based on Family Practice Approach

Implementation of the BHSP was initiated through improving the performance of Integrated District Health System based on Family Practice Approach (IDHS-FPA), which is a new World Health Organization Eastern Mediterranean Region initiative adopted by the Ministry of Health in Iraq which was introduced as a pilot in four districts in the country including Baghdad, Kirkuk, Missan and Erbil governorates. IDHS-FPA is the tier where health care delivery comes into direct contact with the community, strong participatory planning and close and effective communication of all segments of the community at district level play a vital role in enhancing the performance of the health system at both national and sub-national levels. The initiative aims at assuring universal, equitable and efficient access to essential health services for every individual especially the most vulnerable (children, women and elderly) residing in the catchment area of a Primary Health Care Facility.

In order to set the base line for this initiative, WHO Iraq Country Office in collaboration with the WHO Regional Office developed *Assessment Guidelines and Tools*. These tools cover eight areas: National level indicators, district level indicators, PHC facility assessment, the policy commitment to DHS strengthening based on Family Practice Approach, District Health Management and Support System, Social Determinants of Health and Inter-sectoral Action for Health, District Hospital Information and Community Organization and Mobilization. Adaption of the assessment tools to Iraq context was initiated in February 2011 in Erbil and finalized in April 2011 in Beirut.

1.2 Family Practice Approach

Iraq started the implementation of Family Practice in 2006 with the technical assistance of WHO and the co-financing of some activities with the MoH. Today, Iraq is running 40 PHC Centres that are implementing the Family Practice Approach.

In order to contribute to the already ongoing efforts WHO with the support of this project rehabilitated four PHC centers and fully equipped five PHC centers. These centers are located in Basra, Baghdad (Al Karkh and Al Rasafa), Mousel and Karbalaá. The five facilities will be able to establish a successful model of health services delivery by implementing BHSP based on the IDHS with focus on Family Practice Approach. During 2011, all of the physical rehabilitation work started with a total cost of USD 567,748, two out of the four facilities were completed and handed over to the MoH, while the work is still on going in the other facilities. Based on the needs assessment mentioned earlier, the five facilities were fully equipped with medical and non-medical equipment with a total cost of USD 713,636. Overseas training was also provided prior to the installation of the some of the equipment such as the dental units, where two engineers from Mousel were trained in UK.

1.3 Integrated Management of Childhood Illness (IMCI) and Nutrition:

In addition the following National Training Activities (NTAs) were implemented in order to promote and expand the use of innovative interventions aiming to improve the health of mothers and children and thus will accelerate the progress towards MDGs 4 and 5. Five NTAs were undertaken to train 25 assessors in order to undertake the assessment of mother baby friendly hospital initiative. Seven NTAs were conducted successfully in order to train 175 doctors and nurses on the 10 steps of Mother Friendly Hospital Initiative.

Generation of knowledge and evidence is crucial for evidence based decision making and planning. Thus WHO supported MoH to undertake research pertaining to the following areas identified by MoH: 1) Breast Feeding 2) Measure the Indicators of Information Technology and 3) Job Satisfaction at central MoH.

WHO also supported the implementation of Integrated Management of Childhood Illness (IMCI) at PHC facilities implementing the programme as a pilot as follows:

An 11 days IMCI case management training course for 24 physicians working at primary health care centers in Baghdad and Babylon was conducted. Similarly, 5 days training course on IMCI was conducted for 20 paramedics who work in PHC centers. Additionally a 3 days follow up training course on IMCI was convened for 12 health professionals.



Rehabilitation and Expansion of Bab Al Mouadham PHC Baghdad/ Al



Rehabilitation and Expansion of Al Shohadaa PHC Baghdad/ Al Karkh



Baby Regular Check in the PHC center in Missan

Output 2: The ability of MoH on Human Resources planning is enhanced.

WHO assisted MoH in order to strengthen its capacity to precisely plan, deploy, retain and train the right number and right mix of human resources according to the forecasted needs.

The above efforts were continued in 2011, helping the MoH in drafting the Human Resources for Health (HRH) strategy, where a shortened version of the HRH assessment tools (originally developed by WHO Regional Office) was finalized by WHO Regional Office and it was shared with the MoH. Under the request of the MoH, a 2nd training on the shortened version of the assessment tools was conducted for the HRH Steering Committee members in Amman during the period of 21-23 June 2011. By the end of this training, the following objectives were achieved: Revisit the key challenges and opportunities for improving HRH situation in Iraq; Identify the technical constrains in using HRH assessment tools; and agree on the way forward.

It is worth mentioning that the HRH assessment was conducted after this training and the draft report was produced, but this activity was completed under Iraq Public Sector Modernization Project, which is also implemented by WHO team. On another hand, as part of the capacity building development 3 MoH officials working for Human Resources for Health Directorate has successfully completed 8 weeks fellowship in the Faculty of Medicine- Suez Canal University-Egypt. The aim of this fellowship was to motivate the health managers to develop and implement strategies to achieve an effective and sustainable health workforce.

Output 3: National Health Management Information System Strengthened.

Reliable and timely data is essential to delivering public health services. Over the past few years, Iraq invested significantly in a Health Information System (HIS) through the acquisition of hardware and software equipment and technical expertise. However, ad-hoc and fragmented efforts to revamp the various components of HIS have had little tangible effects especially on the quality information that could adequately support evidence-based health care planning and decision making. This drawback has been attributed, to a large extent, to lack of a clear HIS vision, policy and strategy. Hence, the exercise of developing a national Health Information System Strategy was initiated under this programme.

The exercise started by conducting a Stakeholders Meeting for Health Information System (HIS) in Amman October 2010, by the end of this meeting the MoH officials and other stakeholders decided on developing HIS strategy and the team was trained on the assessment tools that were based on the *International WHO Health Metrics Network*. Three national meetings were conducted by the Technical Committee during which the regional assessment tools were adapted to Iraq context.

Under the request of MoH another meeting was organized by WHO in Erbil 16-17 February 2011 with the HIS Technical Committee with the objectives to: re-orient the HIS technical committee with the standards and components of HIS including the HMN framework for assessment; review and exercise the HIS assessment tools; Present the Rapid Assessment (RA) tool for Civil Registration and Vital Statistical (CR&VS) system and prepare ground for the RA of CR&VS in Iraq; and agree on the timeline for the assessment finalization.

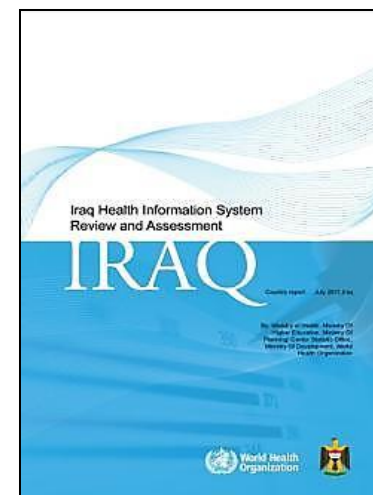

Iraq Health Information System Review and Assessment (HIS)

Based on the outcome of the above mentioned meeting, the assessment took place in Baghdad in a national workshop on 8-10 March 2011. The final report was endorsed by H.E. the Minister of Health. This report will be used as a basis for the development of the national HIS strategic plan.

It is worth mentioning that the report calls for identifying the pressing needs and implementing the most effective interventions to reform and strengthen the HIS and to prioritize and streamline the inflow of resources into the health care system. The assessment report concluded that the NHIS in Iraq was assessed adequate (62%). This score is interpreted as weak NHIS. To serve its perceived objectives, the system needs to be reformed and strengthened. Therefore, it is recommended that the current assessment exercise should lead to developing a HIS Strategic Plan for Iraq, as soon as possible.

Output 4: Sustainable Financing and Social Protection System of MoH Developed.

National Health Accounts and Health Expenditure Review:

The first National Health Account Report for Iraq has been published. The NHA is a powerful analytical tool used to assess health care financing function in health system. NHA will lay out solid foundations for government of Iraq to manage and sustain scarce resources in the health sector and provide basic information related to health financing needed to develop health care financing policies. The findings and conclusions of national health account analysis will have a great impact on shaping policy reforms in the field of health financing in Iraq. The first round of national health account that is finalized represents an excellent achievement of national health teams and represents a milestone in assessing health care financing in Iraq and in improving the overall health system performance in order to achieve the health system goals of improving health, reducing health inequalities, securing equity in financing and responding to the population's needs and expectations.

A national training for NHA team took place during 17-20 January 2010 in Baghdad. The aim of this training was to understand the context and reasons for the development of NHA methodology; be able to communicate the basic concept of NHA, what it attempts to measure, and its role as a tool for the policy process; and recognize the distinctions and similarities of various tools for measuring health expenditures. Finally, costing methodology manual for the BHSP in Iraq was drafted and a national training for the MoH officials on this manual took place in Baghdad in May 2010.

Based on the above proceedings a nationwide National Health Account (NHA) survey was launched by MoH with technical and financial support of WHO. The aim of this survey was to collect the needed information for the NHA exercise from the different stakeholders and thus to provide MOH with the best financing options which will serve as a critical input to the formulation of National Health Financing Strategy.

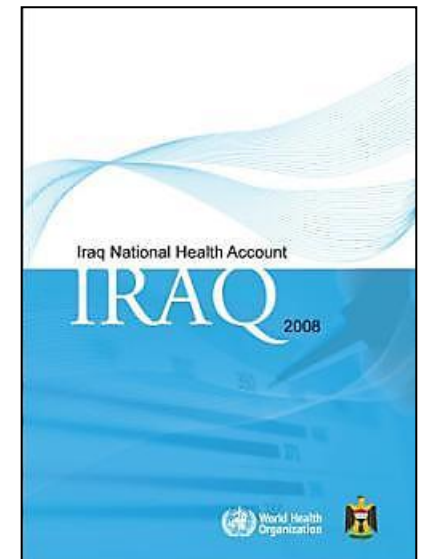

Iraq National Health Account (NHA)

The data collection started in mid July 2010 and was completed by the end of August 2010. The data entry and analysis was completed by the end of November 2010. The survey included 16 district hospitals, 98 Main Primary Health Centers and 48 Sub Primary Health Care Centers, so all in all survey results were derived from 162 health facilities. The final report of the preliminary NHA for Iraq will be ready by mid March 2011.

The work continued in 2011, where Iraq Country Office in collaboration with EMRO organised a three days training workshop on Health Care Financing (HCF) in Amman during the period of 27, 28 February- 1 March 2011. This training workshop aimed at finalizing the 1st NHA report for Iraq. During the above mentioned workshop the National NHA Steering Committee was trained on different topics of HCF. In order to enhance the hands on experience of the National NHA team, the team was assigned to use the real data during the group work sessions as well as guidance was provided on how to populate the NHA matrices using the figures of Iraq. The aim of this practical exercise was to enhance the skills of the National NHA team on the use of software and thus institutionalize the capacity building efforts which will enable the National team to carry out the upcoming rounds of NHA with minimal or no external assistance.

After the above said workshop, the draft report was finalized by the Iraqi team, endorsed by H.E. the Minister of Health, edited, translated into Arabic, published and disseminated to all concerned parties, including MoH, WHO Regional and HQ Offices and other UN agencies.

Moreover an expenditure review for basic health services in Iraq was conducted which contributed to the analysis of financing situation in Iraq and was used in the NHA analysis and diagnostic work under Iraq public sector modernization project.

Output 5: Enhanced MoH leadership and Governance.

5.1 Millennium Development Goals (MDGs): The United Nations Millennium Development Goals (MDGs) are eight goals that all 191 UN member states have agreed to try to achieve by the year 2015 including Iraq. In 2009, Iraq tailored the international MDGs to the Iraqi context, and a national MDGs Steering Committee was formulated, where the MoH was an integral part of this committee. In light of this and in order to further raise the capacities of MoH officials at central and governmental levels on MDGs WHO Iraq Office in collaboration with UN ESCWA organised a national training workshop in Erbil during the period of 6-10 February 2011 on (MDGs). This activity comes as a follow up to September 22-28/ 2010 training workshop, which was conducted for 20 Senior Leaders from the MoH and other line ministries at the Central and Southern Governorates, who met under WHO auspices in Beirut, for an intensive leadership development experience designed to strengthen the pursuit of MDGs for the people of Iraq. The February 2011 activity was initiated under the request of the MoH in order to cover the Northern Governorates needs to be trained on MDGs.

The training workshop objectives were to raise the awareness on the global MDGs and the national MDGs tailored for Iraq with a special focus on Health related MDGs. The main discussion focused on the current situation of Iraq with regard to health MDGs; strengthening

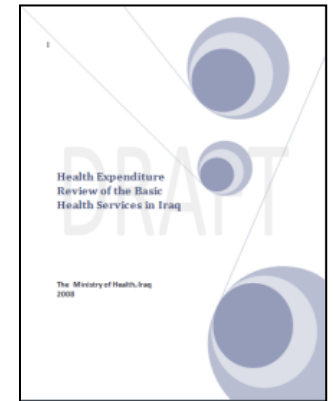

Health Expenditure Review of the Basic Health Services in Iraq 2008

Planning, Monitoring and Evaluation as well as reporting functions of the government officials, taking into account the National Development Plan and the Health Sector Strategy in addition to other related national strategies.

A total of 20 participants from both Central Ministry of Health in Baghdad and Central MoH in Erbil as well as from DoH in Erbil, Sulimanyia, Dohuk and Kirkuk. The private sector was represented in the mentioned workshop by the Head of the Dental Syndicate in Baghdad. By the end of this training workshop, the following was agreed as recommendations and way forward for MDGs: Advocate for formulation of an inter-sectoral committee for MDGs; Assign a focal point for MDGs at the central MoH in Erbil; Conduct National Training Activities in all the 3 governorates on MDGs; Alignment of Strategies, Plans with NDP, MoH Strategic Plan and MDGs for Iraq; Repeat the workshop for policy makers in the region; National awareness for MDGs in the media; Involvement of private sector and other line ministries in MDGs.

5.2 Social Determinants of Health

The social determinants of health are the conditions in which people are born, grow, live, work and age, including the health system. These circumstances are shaped by the distribution of money, power and resources at global, national and local levels, which are themselves influenced by policy choices. The social determinants of health are mostly responsible for health inequities - the unfair and avoidable differences in health status seen within and between countries.

Responding to increasing concern about these persisting and widening inequities, WHO- Iraq Organized on the 3rd of May 2011 a three-days training workshop on “Social Determinants of Health (SDH): Concepts and Tools to Promote Equity in Health in Iraq” was conducted in Amman to raise the profile of SDH and health equity in Iraq. In this connection, the workshop was initiated to build on the fact that health systems are themselves social determinants of health. The main objectives of the workshop were to identify the challenges to the achievement of health equity in a conflict setting, and to propose a Plan of Action and identify sustainable structures to address these issues. It is worth mentioning that incorporating Health in All Policies will assist leaders and policy-makers to integrate considerations of health, well-being and equity during the development, implementation and evaluation of policies and services. During the workshop, the participants from different ministries and syndicates including the Ministry of Health, Finance, Women Affairs, Defense, Labor and Social Affairs, Education, head of the Medical Syndicate and Head of the Nursing Syndicate were introduced to each other and had the opportunity to engage in group work to identify and prioritize six SDH and health inequities in Iraq and to work on a plan of action to put the multi-sectoral structure of SDH Steering and Technical Committees within the MoH..

5.3 Leadership and Strategic Planning

To date a total of 45 countries have developed/revised their National Health Strategic Plans showing an increase of 42% in the past 4 years. These plans are more comprehensive and are based on good situation analysis. In many countries these plans are the basis for harmonizing partnerships, ensuring alignment and facilitating coordination. They also contribute to strengthening country ownership and establishment of mutual accountability for results.

Hence, WHO in collaboration with John’s Hopkins University, organised a five days training workshop on Leadership and Strategic Planning in Istanbul-Turkey during the period of 23-27 May 2011. The main objective of this training was to strengthen the capacity of the members of technical committees of the MoH responsible for updating the national MoH strategies on the strategic planning cycle, in order to equip them with the knowledge and skills needed to revise and update the Health Sector Strategic Plan for 2008-2013. This training is considered as an

initial step towards revising the PHC part of the mentioned strategy, where WHO technical assistance was requested earlier by the Ministry of Health.

The delegation was headed by the Deputy Director General for Planning and Resource Development from Baghdad MoH and Director General of Planning from MoH of KRG. It is worth pointing out that representatives of planning departments of most governorates i.e. Karbalaa, Najaf, Salah ELDean, Basra, Wassit, Diala, Anbar, Babil, Mousel, Sulymania as well as Baghdad took part in the mentioned training. By the end of this training workshop, a set of recommendations was agreed among all participants on the way forward for revising the Health Sector Strategic Plan (2008-2013) in both the Central Ministry and KRG Ministry of Health.

5.4 Mental Health

Mental illness is particularly important because its burden is often underestimated. It remains a stigma and has detrimental effects on the person and society. According to Iraqi Mental health survey 2007, although 35% of Iraqi people are suffering from distress and 16% had at least one mental illness during their life span, mental services is provided to 2.2% of mentally ill people. Due to the above facts, public awareness and early intervention at the very first level of care become increasingly essential. Raising awareness of the PHC workers on the role of mental health as a basic foundation to achieve general health for the person himself and his family, and the possibility of prevention of mental disorders was one of the main objectives that was achieved during the implementation of this programme; as well as raising knowledge in mental health situation and mental disorders.

Improving skills of the PHC health workers to provide proper mental health services for the needy people was the ultimate goal of this project. As shown in the below given graph a total of 57 National Training Activities (NTAs), three NTAs for each directorate of health, 4-days each, for general practitioners and nurses at primary health care level has been conducted successfully as per the agreed action plan. A total of 1685 health professionals have been trained, out of which 1218 were male participants and 467 were female participants. These trainings covered all the 19 governorates with an average participation of 25-30 trainees in each session and will make sure that mental health services are provided under the umbrella approach of primary health care.

This capacity building programme was initiated in a Training of Trainers (ToT) workshop organized in April 2011 in Erbil, with the objectives to: revise WHO mental health training modules and produce a standardized training package adopted to the context of Iraq; assess the current situation of mental health in Iraq; identify the suitable WHO national mental health manuals to be used for training PHC health workers. This workshop was followed by another ToT in Erbil in May 2011, where the training modules that were used as the training material for the 57 NTAs were updated, finalized and adopted as the formal curriculum, in addition trainers were oriented on these modules and action plan for NTAs implementation was also agreed.

In order to evaluate the 57 conducted NTAs as part of 'integration of mental health in primary health care', WHO is organizing along with the MoH officials for mental health a follow up workshop, to come up with lessons learnt and recommendations for the future implementation of the mental health programme. This workshop is expected to take place in February 2012.

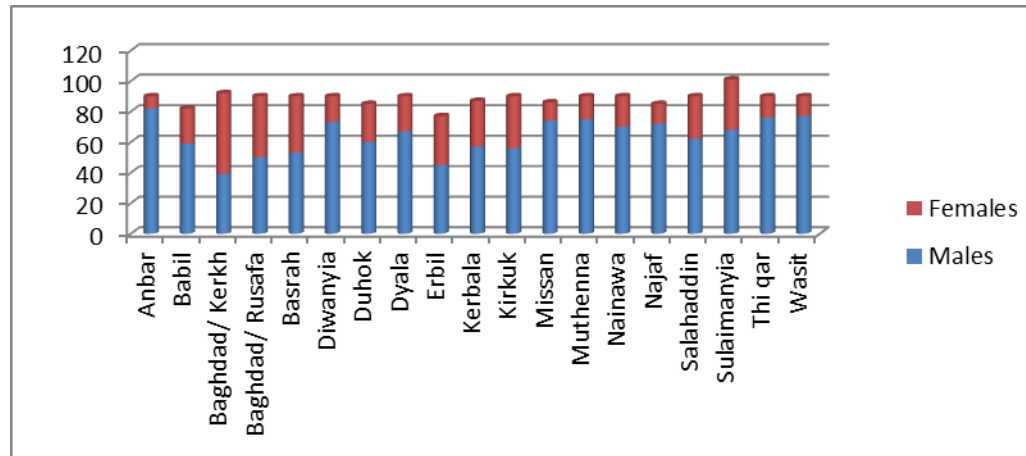

No. of trained MoH staff on Integration of Mental Health into PHC classified by governorate and gender

Summary of Capacity building activities supported by Primary Health Care Phase II project:

Institutional development including capacity building of Human Resources for Health has been identified as one of the main priority area which has to be considered by partners working in health sector. In these lines a large array of capacity building activities have been carried out by WHO Iraq office to strengthen the various building blocks of health system and mainstream the principles of PHC in all initiatives especially related to health services delivery. During the last two years of PHC phase II project 3602 health professionals have been trained in technical areas related to all the 6 building blocks of health system. Out of this total number 2507 were male health professionals and 1095 were female health professional from all levels of health system. 88% of all these capacity building activities were convened inside Iraq and the remaining 12 % took place in countries of the region.

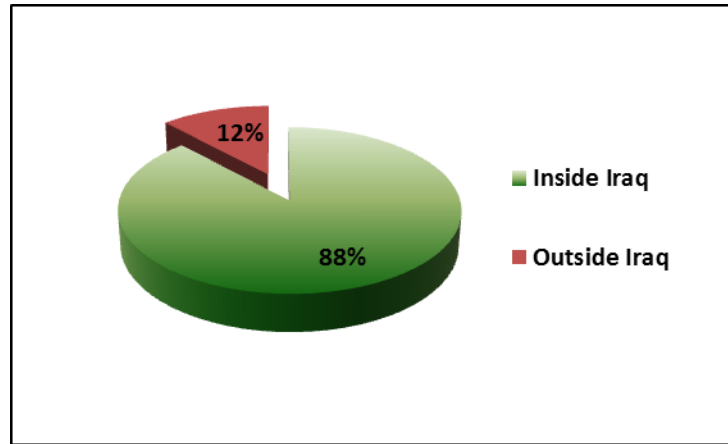

Percentage of capacity building activities conducted inside and outside Iraq

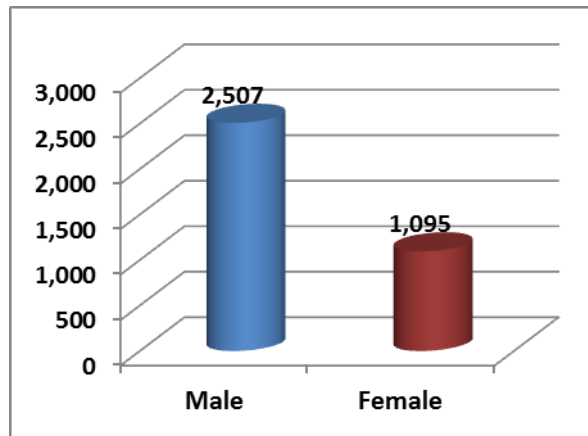

No. of trained cadres classified by gender

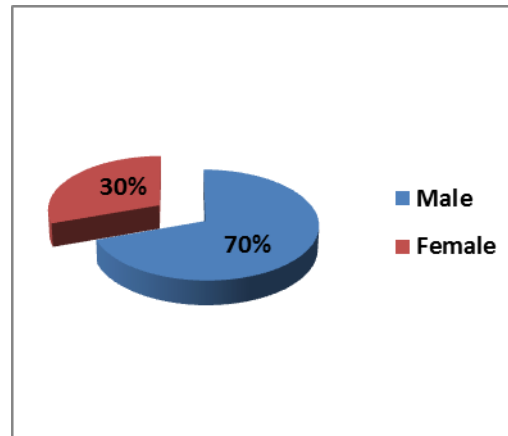

Percentage of trained cadres classified by gender

I. Purpose

The aim of Strengthening Primary Health Care System (SPHCS) phase II project is to support the MoH efforts in the area of Health Sector Reform and strengthening the decentralized District Primary Health Care (PHC) System in Iraq. The restructuring of the system will improve equity, efficiency, effectiveness and responsiveness of system. This is in line with the Ministry of Health (MoH) articulated vision for PHC as 'an accessible, affordable, available, safe and comprehensive quality health service of the highest possible standard that is financially sound and founded on scientific principles in order to meet the

present and future health needs of Iraqi people regardless of their ethnicity, geographic origin, gender or religious affiliation.' This vision calls for an integrated reform of the Health Care System which is the main objective of this project. This project is also in conformity with the MoH goal to transform inefficient, centrally-planned and curative care-based services into a new system based on prevention and evidence-based, equitable, high quality, accessible and affordable primary health care.

This project is a WHO-UNICEF joint project that builds on previous achievements under the Strengthening of Primary Health Care System (SPHCS) Phase I project in Iraq. The project is designed to contribute to upstream national policy level and at downstream health service delivery level.

The immediate objectives of phase II are to (a) invest in the national capacity of MoH/DoH staff in targeted areas to improve Integrated Health Services Delivery, including community psychosocial support (b) invest in improving the Human Resources Planning capacity for the MoH staff (c) strengthen the national capacity of National Health Information System (d) strengthen the National Health Care Financing System (e) strengthen the health governance and policy environment.

SPHCS Phase II project has been designed according to the national priorities and in conformity to the Health and Nutrition Sector goals, objectives and benchmarks as stipulated in the National Development Strategy (NDS) 2007-2010, International Compact with Iraq (ICI), UN Assistance Strategy for Iraq 2008-2010 and the Millennium Development Goals (MDGs). SPHCS project will contribute to successful accomplishments of the following strategic health and nutrition sector goals and objectives defined jointly by the government and partner agencies.

The implementation of this project has put in place the basic infrastructure for achieving the ICI goal for health sector, which states: 'Improve health and nutrition of all Iraqis as a cornerstone of welfare and economic development, increase spending in health from 2.5% to a minimum 4% of GDP to secure access to basic health care for all while preserving the current share of payroll.

Similarly, the SPHCS project has been strongly linked to the national priorities as stipulated in the National Development Strategy (NDS) for Iraq. In order to fulfill the benchmark commitments of ICI the NDS 2007-2010 has been put in place by the Government of Iraq (GoI) to address the various priorities which were identified by the government in a more concrete and precise manner. The NDS will contribute to the attainment of the ICI health sector goals by focusing on the following strategic priorities:

- Strengthen the national healthcare delivery system, and to reorient it from being hospital-focused to being based on Primary Health Care delivery.
- Strengthen emergency preparedness and response in order to address the needs of Iraqis, especially vulnerable populations, while promoting a healthy living environment.

Moreover, the SPHCS phase II project is in line with the UN Iraq Assistance Strategy 2008-2010. This assistance strategy which will guide UN activities from 2008-2010 has been developed in consultation with the government of Iraq, donor community and NGOs to ensure that it keeps with national priorities namely the National Development Strategy, objectives set forth in the International compact with Iraq (ICI) and

MDG benchmarks. The SPHCS project will contribute substantially to the achievement of the Health & Nutrition Sector related objective of the UN Iraq Assistance Strategy which states that:

By 2010, health and nutrition related programs enhanced to ensure 20% increase in access to quality health care services with special focus on vulnerable groups.

It is also in line with the UN Development Assistance Framework (UNDAF) for Iraq (2011-2014) that presents and describes the UN collective response to national development priorities. This project is contributing to the 5 priorities that were identified by the UNDAF with emphasis on priority number one and four stated below:

- Improved governance, including protection of human rights;
- Increased access to quality essential services.

It is worthwhile to reiterate the fact that the various outputs undertaken by this project will eventually contribute to the achievements of the following Health and Nutrition Sector related MDGs.

- Reduce child mortality (MDG 4)
- Improve maternal health (MDG 5)
- Combat HIV/AIDS, malaria, and other diseases (MDG 6)
- Eradicating extreme poverty and hunger (MDG 1)
- Ensure environmental sustainability (MDG 7)

II. Assessment of Programme Results:

There are clear signs of improvement of health status in Iraq over the years 2006-2011. The infant mortality dropped from 35 per 1000 live births (MICS 3, 2006) to 32.9 per 1000 live births (MICS 4 2011) in 2011. The under 5 Mortality dropped from 41 per 1000 live births (MICS -3, 2006) to 37.9 per 1000 live births in 2011 (MICS 4 2011). A substantial improvement has been seen in the proxy indicators for maternal health for instance the percentage of deliveries attended by skilled attendants, the percentage of deliveries conducted in the institutions and the contraceptive prevalence rate which refers to improvement in the maternal health status. This can be attributed to improve access to Primary Health Care services especially the increased utilization of maternal and child health services and the introduction of the Integrated Management of Childhood Illness (IMCI) into primary health care level and the implementation of the confidential enquiry of maternal deaths as part of the surveillance system. There were no major killer outbreaks in Iraq during the past few years, despite national and regional vulnerabilities resulting from poverty (and malnutrition), low coverage of vaccination against main diseases, low access to potable drinking water, sanitation, education and other social services. The SPHCS project contributed to the accomplishment of the above mentioned achievements by focusing on the following outputs at National level.

1. Implementation of Basic Health Service Package (BHSP) through Integrated District Health System based on Family Practice Approach (IDHS-FPA).

By the end of this project the Ministry of Health have packaged the services the ministry is providing in one document that is the ‘Basic Health Service Package’ this package is defined as a minimum collection of essential health services that all population need to have a guaranteed access to. The MoH has also adapted this document as an official guideline that paves the way for successful reform of the health system and will establish the basic and essential milestones of a decentralization of the PHC system based on Al Ma-Ata declaration.

It is worth to mention that, the implementation of this package has started through implementing the ‘Integrated District Health System through Family Practice Approach’ which is a new initiative in EMRO region that aims at assuring universal, equitable and efficient access to essential services for every individual especially the most vulnerable one residing in the catchment population of the PHC facility.

Furthermore, under the same initiative WHO has successfully handed over 4 PHC centers after rehabilitating these centers and equipping them fully with medical and non-medical equipment. It is worth to mention that the 4 centers are now fully functional, providing quality basic health services to the population in the catchment area.

All of the above mentioned initiatives were coordinated with other international partners in order to build upon each other strengthens and avoid duplication; the major partners were UNICEF, UNFPA and USAID.

Output 2: The ability of MoH on Human Resources planning is enhanced.

One of the identified priorities by the MoH that was translated in the project log frame was to help MoH in drafting Human Resources for Health Strategy (HRH). Many efforts were under taken under this project and an assessment for the HRH sector was drafted and finalized. This assessment will be used as a major input to the process of drafting the MoH HRH strategy which is planned to be completed under the IPSM project.

Another area of work that this project was concerned with is ‘Strengthening Accreditation of Medical Education’ under this project the Iraqi National Guidelines for *Standards for Establishing and Accrediting Medical Schools*, were developed, endorsed and implemented. Further to that, a road map for medical education reform was developed; institutional plans-of-action for colleges to obtain accreditation; and national plan to accredit colleges was developed and agreed upon among the different players.

It is worth to mention that national capacities were built through different meetings, workshops and abroad trainings. The efforts to continue working under this crucial area of work will be continued under other projects that WHO is implementing including the IPSM project.

Output 3: National Health Management Information System Strengthened

Developing HIS strategy is also one of the priorities that was identified by the MoH and was part of this project outcome. The process of developing this strategy was initiated under this project, after building the national capacities, an assessment to HIS was conducted by the national counterparts and a report was produced and endorsed by the MoH officials.

The assessment report concluded that the NHIS in Iraq was assessed adequate (62%). This score is interpreted as weak NHIS. To serve its perceived objectives, the system needs to be reformed and strengthened. Therefore, it is recommended that the current assessment exercise should lead to developing a HIS Strategic Plan for Iraq, as soon as possible. The Strategic Plan should reflect the findings of this report.

It is worth to mention that the process of drafting and finalizing the strategy is planned to be continued under the IPSM project.

Output 4: Sustainable Financing and Social Protection System of MoH Developed

The first NHA report for Iraq was published under this project. The first attempt of this report shed some light on health care financing in Iraq and has provided some important findings, which states, the level of health care spending, as per capita and as share of GDP, remains less than the average of countries with similar income. However the structure of health care financing shows a fair degree of equity in view of the limited burden on households who share only one fourth of the total health bill.

The high level of government contribution in health care financing reflects the constitutional commitment of the state to secure health and social security to individuals and families. Government through MoH is providing universal coverage by social health protection, which constitutes an important achievement of the Iraqi health care system.

In general, Iraqi health funds are primarily spent on curative care (more than 37%). A considerable share, 36.8%, goes towards pharmaceuticals dispensed for outpatient care, and 22.4% is spent on administration cost and salaries (*for further details please refer to Table 5, Figure 4*).

During 2013, MoH is planning to produce the second NHA report for Iraq, and the MoH has shown its readiness to provide the financial support for developing the second NHA report while WHO will be responsible for providing the technical expertise.

Output 5: Enhanced MoH leadership and Governance.

In order to Enhance the MoH Leadership and Governance Skills, many trainings and workshops under different strategic areas were conducted under this project including: CBI, MDGs, Social Determinants of Health, Leadership and Strategic Planning. These trainings were conducted to the national counterparts using the expertise of WHO regional and HQ expertise in addition to contracting consultants from

other UN sister agencies such as UN ESCWA and consultants and firms from the most well-known and strategic partners to WHO such as Johns Hopkins University and American University of Beirut, in addition to regional training centers in order to provide our national counterparts with the best regional and international exposure and expertise.

In total WHO have trained around 5,000 people under this project over the last 4 years. These trainings varied between having national training activities inside the country with local trainers and /or international consultants, conducting training activities and workshops in neighboring countries such as Jordan, Lebanon Syria and Turkey, in addition to sending our local counterparts to regional and international conferences and meetings to represent Iraq and participate in these regional and international initiatives in different countries within MENA Region or Europe.

By the end of each training activity, WHO made sure that participants were provided with certificates for their participation and/or diplomas after finishing their long term training courses.

- **Outputs:**

An array of vital measures were taken during the project reporting period to successfully accomplish the above output which is meant to strengthen the capacity of MoH in order to have a context specific services delivery model. The following achievements have been made in the following areas of strategic importance which will pave the way for the successful reform of health system based on the principles of PHC and will establish a successful model of health services delivery which will respond to the health care needs of Iraqi population in an effective and sustainable manner.

1.1 Implementation of Basic Health Service Package (BHSP) through Integrated District Health System based on Family Practice Approach (IDHS-FPA)

The MoH with the technical and financial support of WHO developed the Basic Health Service Package (BHSP), the Basic Health Services Package (BHSP) is defined as a minimum collection of essential health services that all population need to have a guaranteed access to. The package was approved by the MoH in a formal session that was conducted in Baghdad in February 2010.H.E. the Minister of Health declared that this package will pave the way for a successful reform of the health care system and will establish the basic and essential milestone of a decentralized PHC system which is based on the principles of Alma-Ata Declaration. This package was translated to Arabic, published and distributed.

An extensive policy support was given by MoH of Iraq in order to initiate the implementation of BHSP.A National Steering Committee headed by the Deputy Minister of Health for Donors Affairs and Technical Committee for BHSP implementation was formulated.

Implementation of the BHSP was initiated through improving the performance of Integrated District Health System based on Family Practice Approach (IDHS-FPA), which is a new World Health Organization Eastern Mediterranean Region (EMRO) initiative adopted by the Ministry of Health in Iraq which was introduced as a pilot in four districts in the country including Baghdad, Kirkuk, Missan and Erbil governorates.

The initiative aims at assuring universal, equitable and efficient access to essential health services for every individual especially the most vulnerable (children, women and elderly) residing in the catchment area population of a Primary Health Care Facility.

IDHS-FPA is the tie where health care delivery comes into direct contact with the community, strong participatory planning and close and effective communication of all segments of the community at district level play a vital role in enhancing the performance of the health system at both national and sub-national levels.

A District Health System Approach also allows detection of all the problems and shortcomings that may exist elsewhere in the health system. In other words, a district health system in many ways mirrors the status of the national health system and any attempt to improve it should eventually encompass the health system as a whole if sustainable outcomes are to be achieved.

The implementation of IDHS-FPA in the selected four districts will provide a golden opportunity to learn about the demographic and socio-economic factors, specific challenges affecting the health of population in the targeted districts which will enable the Ministry of Health (MOH) to take timely and appropriate actions to mitigate the negative impact on health services delivery and thus health outcomes.

In order to set the base line for this initiative, WHO Iraq Country Office in collaboration with the WHO Regional Office developed *Assessment Guidelines and Tools*. These tools cover eight areas:

National level indicators, district level indicators, PHC facility assessment, the policy commitment to DHS strengthening based on Family Practice Approach, District Health Management and Support System, Social Determinants of Health and Inter-sectoral Action for Health, District Hospital Information and Community Organization and Mobilization. Adaption of the assessment tools to Iraq context was initiated in February 2011 in Erbil and finalized in April 2011 in Beirut.

A three days meeting was conducted in Erbil during the period of 13-16 February 2011 with key MoH Officials from the central and Erbil ministries. The objectives of this meeting were to: agree on the strategic direction of Primary Health Care Programme implementation for the coming 4 years; review the action plan of Basic Health Services Package Implementation (BHSP); revise the Assessment Tools for Integrated District Health Systems Based on Family Practice Approach (IDHS-FPA).

After three days discussion with the Director of Donors Section, Director of PHC Department, Director of Health Centers Section, Director of Family Medicine Section, the Head of Therapeutic Department/Technical Affairs, and the Director of Planning Department in Erbil, the IDHS-FPA was adopted in Iraq for the coming 3 years to implement the BHSP within this approach. The agreement was also to pilot the implementation of IDHS-FPA in four districts within four different governorates.

Erbil meeting was followed up by five days introductory workshop on implementation of Basic Health Service Package (BHSP) through Integrated District Health System based on Family Practice Approach (IDHS-FPA) which was held from 16- 21 April 2011 in Beirut, 41 high level government officials from all the 3 levels of government i.e. central MOH in Baghdad and MOH of KRG, piloted governorate and districts participated actively in the workshop. In addition the Representatives of USAID and UNRAW who are working to strengthen Primary Health Care in Iraq at their respective agencies participated also. The workshop was facilitated by WHO experts from Regional

Office and country offices of Iraq, Jordan and Lebanon. The purpose of this workshop was to agree on road map needed for the implementation of BHSP through the IDHS-FPA in Iraq, identify the four districts following standard criteria, identify mechanisms for implementation, surface financial and human resources needs and agree on the contents of the eight assessment tools which will be used to undertake the baseline assessment in the selected districts.

Based on the recommendations of Beirut workshop, another three days meeting was conducted in Amman-Jordan during the period of 13-15 June 2011 for the assessment teams of IDHS that were formulated after Beirut workshop.

It is worth mentioning that out of the 8 assessment tools that were developed, discussed and finalized in Cairo, Erbil and Beirut. Two modules number 6 and 7 which address assessing Primary Health Care Centers and assessing Hospitals in the 4 pilot selected districts needed field data collection and entry, hence, both modules were thoroughly discussed in another meeting in Amman from 13-15 June 2011 with the following objective: to train/supervise the data entry teams and ensure valid and reliable data entry in order to ensure robust data analysis and concrete findings and report. By the end of this workshop, modules number 6 and 7 were approved by the MoH team and coded by WHO consultant in preparation for conducting the assessment. The assessment teams were also trained on data collection and data entry on the Statistical Package for Social Science (SPSS) in preparation for analyzing the outcomes of this assessment and developing District Health System Profile for each pilot district.

Back in Iraq, the trained assessment teams collected the data in accordance with the 8 assessment tools and shared the raw data with WHO office, who in turn analyzed the data with the help of WHO consultant and produced 4 different reports one for each piloted district, reflecting the situation of that particular district in terms of number of health facilities their current situation and functionality and the exact location. Information from these 4 reports will be used to establish a detailed report for each of the district entailing the proposed interventions and the strategies for those interventions aiming to address the bottlenecks and improve health services delivery in those districts.

Following up on this initiative, a training workshop took place in Erbil during the period of 26-29 March 2012. The workshop focused on the planning and implementation phase, based on analysis, discussions and findings of the health system assessment of the four pilot districts. The main objectives of the workshop were to: present and discuss the findings from the health system assessment in the four pilot districts; identify and agree on priorities for each district; establish a mechanism for implementation of interventions; reach a consensus on the 2012–2013 action plan and the expected results for each district; and develop a plan of action on family practice implementation for the Erbil district.

As per the recommendations of the above workshop a Family Practice Specialist was recruited in Baghdad for one month starting 24th of June 2012. The specialist assisted the MoH in implementing the Family Practice Approach in 8 PHC centers, 2 in each of the piloted IDHS districts.

1.2 Family Practice Approach

Iraq started the implementation of Family Practice in 2006 with the technical assistance of WHO and the co-financing of some activities with the MoH. Today, Iraq is running 40 PHC center that are implementing the Family Practice Approach.

In order to contribute to the already ongoing efforts WHO with the support of this project rehabilitated four PHC centers and fully equipped five PHC centers. These centers are located in Basra, Baghdad (Al Karkh and Al Rasafa), Mousel and Karbalaá. The five facilities will be able to establish a successful model of health services delivery by implementing BHSP based on the IDHS with focus on Family Practice Approach. The rehabilitation work was preceded by a *need assessment* which was conducted in the five facilities by the MoH assessment teams and the report was shared with WHO in March 2010. The findings of this report were used to determine the needs of these facilities in terms of rehabilitation and the supply of medical and non-medical equipment.

During 2011, all of the physical rehabilitation work started with a total cost of USD 567,748; by the end of December 2012 the four facilities were completed and formally handed over to the MoH. The rehabilitation was done in accordance with the WHO-MoH agreement, starting by finalizing the Bills of Quantities (BOQs), the bids announcement, bids opening and finally awarding the contracts for the selected contractors.

It is to note that Karbala PHC center was not rehabilitated (even though it was initially on the list) because the need for rehabilitation was minor and despite several announcements no one applied to take care of the rehabilitation. As a result MOH through a written request, urged WHO to only equip the Karbala PHC with needed equipment and the minor rehabilitation need of the facility will be taken care of by Karbala DOH.

	Name of PHC center	Governorate	Estimated Cost in USD	Implementation Period	% of implementation by the end of Dec. 2011	Hand over to the MoH
1	Al Shohadaa	Al Karkh / Baghdad	223,267	120 days	100%	Handed over
2	Bab Al Muadam	Al Rasafa / Baghdad	134,007	120 days	100%	Handed over
3	Al Abbas	Basra	70,725	120 days	100%	Handed over
4	Tammoz	Mousel	82,678	75 days	100%	Handed over
Total cost			567,748			

The rehabilitation work was monitored by four engineers who were contracted on short term basis by WHO to support and technically oversee the implementation progress of physical rehabilitation in close co-ordination with MoH focal points.

Based on the needs assessment mentioned earlier, the five facilities were fully equipped with medical and non-medical equipment with a total cost of USD 713,636. All these equipment were procured, shipped and delivered to the MoH. Overseas training was also provided prior to the installation of the some of the equipment such as the dental units, where two engineers from Mousel were trained in UK.

Procured Items	Total Cost USD	Type of procurement
----------------	----------------	---------------------

1	General and Laboratory Equipment	203,506	International procurement
2	Dental units and devices	73,573	International procurement
3	Imaging equipment	298,500	International procurement
4	Medical Instruments	28,033	International procurement
5	IT equipment	40,200	Local procurement
6	Medical furniture	48,142	Local procurement
7	Non-medical equipment	30,685	Local procurement
Total cost		713,639	

1.3 Integrated Management of Childhood Illness (IMCI) and Nutrition:

Integrated Management of Childhood Illnesses

IMCI is an integrated approach to child health that focuses on the wellbeing of the child and aims to reduce death, illness and disability, and to promote improved growth and development among children under 5 years of age. IMCI include both preventive and curative elements that are implemented by families, communities and health facilities.

The IMCI strategy includes three main components:

- 1- Improving the case management skills of health care staff.
- 2- Improving overall health system.
- 3- Improving family and community health practices.

MoH conducted the following training activities on IMCI supported by WHO:

1. Four national training courses (11 days IMCI case management course) for 88 physicians in Baghdad, Basrah a and Erbil facilitated;
2. Two trainings, 7 day facilitator training course and follow up trainees in for 16 national facilitators from Baghdad, Babil and Anbar governorates;
3. Expansion in the Implementation of IMCI strategy in another 4 governorates, 21 districts and 170 PHC centers which makes the total number of governorates implanting IMCI 14 governorates;
4. Adaptation of the IMCI nursing training modules by the adaptation committee;
5. provision of 500 copies of the Arabic version of Infant and young Child feeding counseling course

1.4 Construction of 13 Primary Health Care Centers

To improve access to quality primary health care services for the remote rural communities, including those how have been affected by high influx of IDPs and Returnees in the south/center part of the country. UNICEF within the current joint ITF project with WHO and as agreed with the SOT in consultation with Ministry of Health, Ministry of Marshland and the health directorates, utilized the available allocation to construct 13 PHCs and two residence houses for the medical staff in the following Governorates (one PHC in Ninewa, Kerbala, Muthana, Babil, and Salah Al-Din; and two PHCs in Basra, Missan, Wassit, Diwaniyah, and ThiQar and 2 staff residences).

The Original Number was 15 PHCCs, but the number decreased to 13 due to inflation in prices; however UNICEF succeeded to mobilize other funds - mainly emergency funds - to construct residency for 9 PHCs instead of 2 PHCs only, to ensure sustainable availability of female medical staff 24 hours throughout the week in the remote rural districts. Additionally MOH request to transfer the amount of money allocated for supplies of PHCCs to construct another PHCC in Makhmoor district of Ninawa governorate which make the number of PHCCs 12.

Two model designs for the new PHCCs and staff residence have been developed in consultation with MOH engineers including the detailed BOQs:

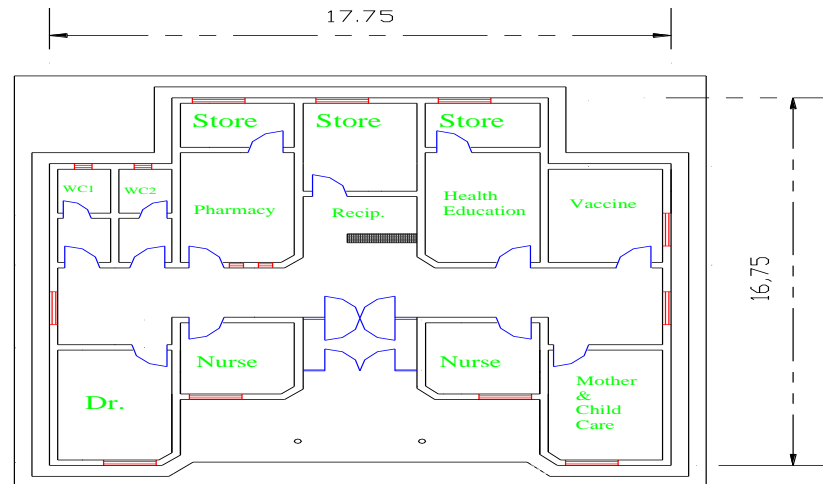



Figure 1 Type A PHC center

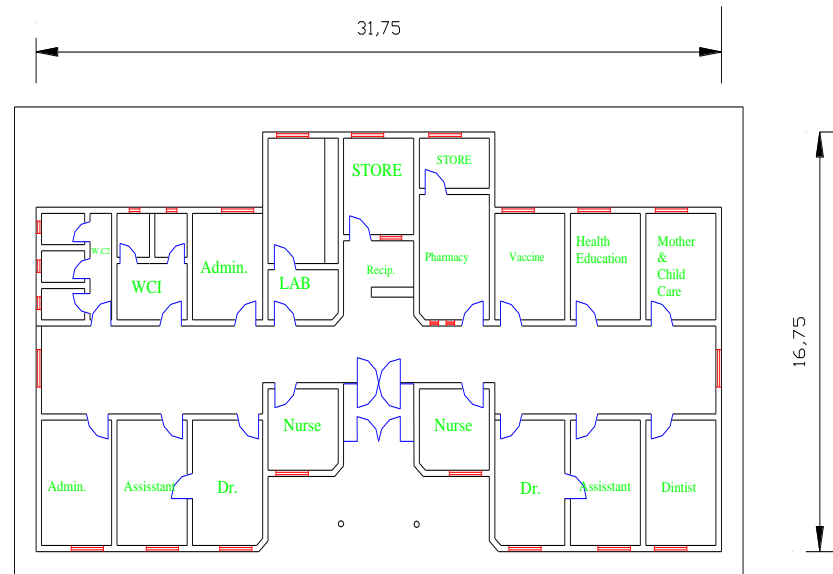



Figure 2 Type B PHC Center



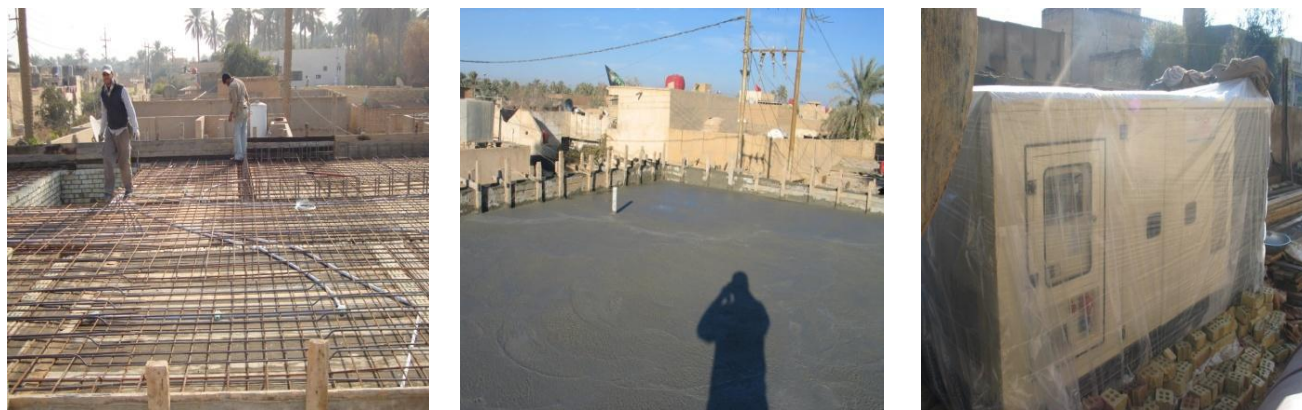

Figure 3 UNICEF engineers closely monitor & document the day to day work

All the 12 PHCs were completed and handed over to MOH/DOHs, the remaining two sites (Babel and Basra) that delayed due to the land ownership and soil testing issues were cancelled by MOH and they commit to construct these PHCCs with their own resources and requesting UNICEF to utilize the remaining balance to:

- a) Train different levels of medical and paramedical staff on proper primary health care interventions (i.e. immunization, management of diarrhea and malnutrition, etc.).
- b) Technical exchange with international institutions on health program planning and management.
- c) Support MOH to conduct job training and focused monitoring and supervision at the peripheral level.
- d) Demand creation on utilization of the available services through conducting targeted social mobilization activities.

Below are the details of PHCCs type and location

Description	Implementation Site	24-March-12
Construction of new PHC center Type B with residence in Al-Fuhood District	Thiqar	100%
Construction of new PHC center Type A with residence in Al-Hamza/Al-Sadair District	Qadisiya	100%
Construction of new PHC center Type A with residence in Al-Shanabrah area, Al-Sumawa District	Muthana	100%
Construction of new PHC in Garmet Bani Saeed Type B	Thiqar	100%
Construction of Al-Rafae PHC type B with residence in Al Kahlah District	Missan	100%
Construction of Al-Usir PHC Type B with residence in Al-Hindia District	Kerbala	100%

Construction of Al-Khoumis new PHC center Type B with residence in Al-Maymouna	Missan	100%
Construction of new PHC in Al-Medaina District with residence	Basra	100%
Construction of new PHC in Nu'mania	Wasit	100%
Construction of new Medical Staff Residence in Chibayesh district	Thiqar	100%
Construction of new PHC with residence in Tureisha village	Salahiddin	100%
Construction of new PHC- Type A in Makhmoor	Ninawa	100%

- Additionally, 213 different level PHC staff working in the same selected districts has enhanced capacity on quality PHC services through conducting several training courses on emergency obstetric care, safe delivery practices, essential neonatal care, growth development and monitoring, and proper management of diarrheal cases and acute respiratory tract infections. Some of these courses are still on-going and targeting additional health care staff.
- Another 3 workshops conducted for a total of 215 doctors and paramedics on the essential new born care, breast feeding promotion and CDD/ARI programme in 3 DOHs to enhance the service provision especially in low performing districts.
- The fund utilized to support a study on the prevalence of anemia between pregnant women is conducted in several governorates in coordination between NRI and MCH department with UNICEF support and the result will be released in couple of months.
- Also this fund was utilized to conduct training workshops for nutrition rehabilitation centers in pediatric hospitals (one workshop for 25 doctors in each governorate) a total of 400 doctors were trained.
- In order to enhance the practice of breast feeding and to increase the exclusive breast feeding practice the fund utilized to conduct TOT training for the nutrition focal points to reassess the pediatric and maternity hospitals which got certified as baby friendly hospitals and to certify new hospitals, in addition 8 workshops done in (Baghdad, Anbar, Kirkuk on the Infant and Young child feeding and breast feeding promotion for 200 health workers).
- In the view of MICS4 data that shows high % of stunting among children below 5 years of age UNICEF utilize this fund to support MOH to procure measuring boards for the PHCCs to strengthen the nutritional surveillance of under 5 children for better identification and follow up of cases and to extend the quality nutrition services into all PHCCs.
- In order to build the capacity of MOH in conducting studies and to build a data base of information at the level of governorates and districts UNICEF used the fund to support 3 KAP studies on CDD/ARI, Breast feeding and consumption of Iodized Salt in 16 governorates a total of 48 health teams (96 doctors and paramedic staff) trained to collect information.
- Also the fund utilized to conduct national study on low birth weight and its causes all over the country, 19 health teams (total of 110 doctors in general and maternity hospitals) trained on collecting information..
- To extend the implementation of IMCI programme in all over the country UNICEF utilized the fund to support MOH conducting 12 training courses in Najaf, Kerbala, Babel, Wasit, Diyala, Baghdad Karkh and Baghdad Rusafa for a total of 275 doctors

1.5 Child Protection

In collaboration with the Child Protection section within the UNICEF Iraq country office, and the “Play Therapy Africa – NGO partner” rolled out a Community Based Psychosocial Support study/assessment, which is the first of its kind in Iraq and its output will convey crucial

understandings and valuable data on psychosocial situation in Iraq. The study has been endorsed by MoLSA and is currently ongoing. Based on the result of this study:

1. Parents, caretakers and community members will reach a deeper understanding of boys and girls emotional and developmental needs enabling the provision of better care practices in selected communities.
2. Selected communities will be empowered and capacitated to enhance internal (resilience) and external (social capital) protective factors for Iraqi children and youth.
3. Boys and girls in Iraq will enjoy a renewed protective environment and an expanded psychosocial wellbeing as a result of strengthened processes of community mobilization, participation and empowerment geared around positive caring practices.
4. Institutional capacity of Government of Iraq to develop and implement psychosocial support programmes for boys and girls and their families.

Output 2: The ability of MoH on Human Resources planning is enhanced.

2.1 Human Resources for Health Strategy

WHO assisted MoH in order to strengthen its capacity to precisely plan, deploy, retain and train the right number and right mix of human resources according to the forecasted needs. Among the efforts it is worthwhile to focus on the importance of two workshops which were specifically held to assess the current situation of MoH and understand the current HRH needs and challenges of the MoH.

The first training workshop was held in Amman from 9-10 June 2010. The workshop was attended by officials from MoH, MoHE, MoE, MoP and WHO/EMRO and a representative from the High Health Council -Jordan and Iraqi Embassy in Amman-Health Attaché.

The objectives of the workshop were to: Share the evolving concept of HRH function of the health system; review the current state of national HRH, including Country Cooperation and Facilitation (CCF) to pave the way for development of HRH coherent and CCF framework; present the concept of HRH observatory and best approach to establish and maintain its structure and core functions in Iraq; and draft work plan for development of nation-wide health workforce plan with WHO technical support.

As a follow up on the recommendations of the above mentioned workshop, WHO Iraq Country Office in coordination with WHO Regional Office and WHO HQ organized the 2nd training workshop in Amman which was held from 24 to 27 October 2010. The main theme of the workshop was to train the participants on the Assessment tools and Strategic Planning on HRH. The workshop covered a number of areas of strategic importance i.e. introduction to the framework and capacity assessment tool for HRH; introduction to the strategic planning, coordination mechanisms, communication and monitoring of HRH. In addition, a six months action plan was designed and approved which will assist MoH to carry out HRH assessment which once completed will be used as an input in the formulation process of HRH strategic plan.

The above efforts were continued in 2011, helping the MoH in drafting the Human Resources for Health (HRH) strategy, where a shortened version of the HRH assessment tools (originally developed by WHO Regional Office) was finalized by WHO Regional Office and it was

shared with the MoH. Under the request of the MoH, a 2nd training on the shortened version of the assessment tools was conducted for the HRH Steering Committee members in Amman during the period of 21-23 June 2011. By the end of this training, the following objectives were achieved: Revisit the key challenges and opportunities for improving HRH situation in Iraq; Identify the technical constrains in using HRH assessment tools; and agree on the way forward.

It is worth mentioning that the HRH assessment was conducted after this training and the draft report was produced, but this activity was completed under Iraq Public Sector Modernization Project, which is also implemented by WHO team.

On another note, as part of the capacity building development 3 MoH officials working for Human Resources for Health Directorate has successfully completed 8 weeks fellowship in the Faculty of Medicine- Suez Canal University-Egypt. The aim of this fellowship was to motivate the health managers to develop and implement strategies to achieve an effective and sustainable health workforce.

2.2 Accreditation of Medical Education

Iraq has a long and distinguished history of medical education in the region and the world. The first medical school in Iraq, established in 1927, was a pioneer that supplied health care providers not only for Iraq, but also for various other countries. With the support of WHO, the Ministry of Higher Education and Scientific Research has worked hard to sustain this heritage and is committed to improving the quantity and quality of medical education institutes in Iraq.

The number of medical schools in Iraq has increased markedly over the past decade, and there is a need for stronger human resources to address the health issues the country faces in the 21st century and to meet the country development goals highlighted in the National Development Plan for Iraq and the Millennium Development Goals.

All available means and methods must be used to ensure that Iraqi graduates are capable of practicing in the reality of a changing world. Mastering core clinical competencies, in addition to acquiring a range of non-clinical (and even non-health-related) competencies, in areas such as management and leadership, information technology and e-learning modalities, is considered a basic prerequisite for any health professional today. Cultural competencies and social accountability are similarly important to ensure graduates are in tune with the needs of the populations and communities they serve.

All of this has highlighted the need for accreditation as a tool to ensure quality and the necessary modernization of medical and health care education.

An initiative on the accreditation of medical schools emerged in April 2007 as a result of recommendations by the Ministry of Health and WHO on medical education and accreditation standards. This initiative was followed by a series of workshops, meetings and consultations in Bahrain, Baghdad Erbil and Amman which led to the endorsement of national accreditation standards and guidelines and self-assessment tools for medical schools, which were based on the WHO/World Federation for Medical Education Guidelines for Accreditation of Medical Schools. It is this system which is now being reviewed.

Under this project, WHO in collaboration with the College of Medicine and Medical Sciences-Arabian Gulf University-Kingdom of Bahrain supported the 'Accreditation and Quality Assurance in Medical Schools Workshop' that took place on 24-27 May 2009. The objective was to enable the participants to set the national standards for the accreditation process and quality assurance of the Iraqi medical colleges that are in congruence with the international standards. A total of 20 participants from all over the country participated in this workshop, representing the Iraqi Medical Colleges, the National Accreditation Committee, the Ministry of Health and the Parliamentarians in addition to the participation of H.E. the Minister of Higher Education. As a follow up of the said activity, the second workshop took place from 12-13 July 2009 in Baghdad with the objective of setting guidelines for Iraqi Medical Collages to assist them in implementing their 'self-reporting studies'. It is worth to mention that by the end of this workshop the 'Iraqi National Guidelines on Standards for establishing and Accrediting Medical Schools' was drafted and finalized.

The above activity was continued in Amman, Jordan where WHO experts joined more than 42 high-level representatives from the Ministries of Higher Education and Research and Health, deans of medical institutions and members of the Accreditation Committee for Iraq, from 27 to 29 February 2012 to evaluate the current status of accreditation of health professions education in Iraq, set priorities, and discuss how to ensure an effective structure and mechanism for a quality accreditation system in the country. The participants agreed to develop a road map clearly outlining steps to be taken and the roles various partners should play in establishing and strengthening accountable accreditation system that is compatible and harmonized with global standards.

Based on the recommendations of Amman meeting, WHO in collaboration with the Ministry of Higher Education, Ministry of Health and the National Accreditation Committee for Iraq, organized 3 days Consultative Meeting from 24-26 September in Erbil to *Strengthen Accreditation of Medical Education Institutions in Iraq*. This meeting included 50 participants representing the MOHESR, MoH, Deans and Representatives from the 23 medical colleges from all governorates, in addition to the participation of the head and members of the National Accreditation Committee.

The meeting aimed to further strengthen the accreditation of medical colleges in Iraq by building on the tremendous amount of work which has already been undertaken in the area of accreditation and quality improvement by experts from WHO and other involved entities. The program for the 3 days meeting has been based on the recommendations and conclusions of the previous discussions especially the recommendations of the latest workshop conducted in Jordan (February 2012).

The main objectives of this consultative meeting were to:

1. Rapidly assess status at medical colleges regarding accreditation and reform;
2. Agree on a road map for medical education reform in Iraq.
3. Prepare plans-of action (POA) for colleges to follow towards accreditation and reform.
4. Technically support colleges to produce valid self-assessment studies (SAS) using systematic and structured tools.
5. Train potential team to conduct site visit towards awarding accreditation using appropriate tools and procedures.
6. Prepare a national plan-of-action for Accreditation Committee to accredit medical colleges.

By the end of this consultative meeting a road map for medical education reform; institutional plans-of-action for colleges to obtain accreditation; and national plan to accredit colleges was developed and agreed upon among the different players.

In addition to that building the capacity of the audience to produce valid Self-Assessment Studies (SAS) documents and to conduct site visits and award accreditation was ensured.

The conclusions of the three days consultative meeting will help the ministry to develop a broader reform agenda which will pave the way towards the establishment of a National System for Accreditation in line with the regional and global standards.

Furthermore it is imperative to note that the following activities were conducted by WHO which contributed to the aforementioned output was conducted in line with the objective of the project and in closer collaboration with the concerned departments of MOH.

In collaboration with Hawler Medical University in Erbil – Nursing Faculty organized the First International Nursing Scientific Conference 23-25 June 2009 in Erbil, which aimed to provide an understanding and acquaintance with contemporary nursing issues on the national and international levels. A plan of action for the next steps for nursing was drafted and agreed upon. WHO further supported this conference by providing the MoH with a total of 25,000 copies of 'Nursing Codes of Ethics Guidebook' to be distributed to the concerned staff at different levels.

In addition, in collaboration with the MoHE, the University of Basra-College of Dentistry and Hawler Medical University in Erbil – Medical Faculty supported a total of 30 students for one month from Basrah University in their 5th year of dentistry to fulfill the requirements of Bachelor of Dental Sciences Degree in different branches in Hawler University to achieve a high quality experience in practical field.

Furthermore, as per the MoH request, a training course on Results Based Management Framework was conducted, during the period of 19-21 October 2009 in Baghdad-AL Rasheed Hotel for a total of 42 MoH officials from the center and the governorates, in addition to participants from Ministry of Environment and Baghdad University. The training was facilitated by the WHO Regional Adviser for Planning, Monitoring and Evaluation supported by four WHO technical Officers. The training objectives were designed to 1) introduces the logical approach and its application for programme development and Results Based Management. 2) Provide training on the preparation and the use of a results framework.

As part of similar capacity building activities and in close collaboration with the concerned technical departments of MOH, the participation of 2 health professionals from the MoH was supported in order to attend in the Regional Workshop: Health Care Professional (HCP) Associations and their role in achieving MDGs 4 and 5 that took place in Amman on 17-19 December 2009. The overall objective of this workshop was to increase the contribution of HCP Associations to national Maternal, Newborn and Child Health plans through a strengthened participation in policy and programme development and an increased alignment of activities to the national targets regarding the achievement of MDGs 4 and 5.

In order to improve the data management skills of health professionals 2 trainings which were held on 6-8 and 13-15 December 2009 in Erbil for data entry personnel especially on how to use the electronic questionnaire adapted in Epi Info software. The candidates for these training were from the sentinel hospitals, forensic centers and from Directorate of Operation. The second phase of data collection started on 1st December for both old and newly included DOHs. Five Laptops and five photocopiers were purchased for sentinel hospitals in the newly added DOHs. WHO also supported the printing of data collection tools in both Arabic and English languages which were distributed to the concerned sentinel hospitals through MoH and Directorate of operation.

Output 3: National Health Management Information System Strengthened

Reliable and timely data is essential to delivering public health services. Over the past few years, Iraq invested significantly in a Health Information System (HIS) through the acquisition of hardware and software equipment and technical expertise. However, ad-hoc and fragmented efforts to revamp the various components of HIS have had little tangible effects especially on the quality information that could adequately support evidence-based health care planning and decision making. This drawback has been attributed, to a large extent, to lack of a clear HIS vision, policy and strategy. Hence, the exercise of developing a national Health Information System Strategy was initiated under this programme.

The exercise started by conducting a Stakeholders Meeting for Health Information System (HIS) in Amman October 2010, by the end of this meeting the MoH officials and other stakeholders decided on developing HIS strategy and the team was trained on the assessment tools that were based on the *International WHO Health Metrics Network*. Hence, the team raised this issue with H.E. the Minister of Health, who in turn approved this initiative and supported it by being the Head of the Steering Committee for developing the HIS strategy.

The MoH formulated also the Technical Committee to follow up on the assessment, the tools consists of a questionnaire with 197 questions divided into the six components: resources essential, health indicators, data sources, data management, information products and dissemination and use. Three national meetings were conducted by the Technical Committee during which the regional assessment tools were adapted to Iraq context.

Under the request of MoH another meeting was organized by WHO in Erbil 16-17 February 2011 with the HIS Technical Committee with the objectives to: re-orient the HIS technical committee with the standards and components of HIS including the HMN framework for assessment; review and exercise the HIS assessment tools; Present the Rapid Assessment (RA) tool for Civil Registration and Vital Statistical (CR&VS) system and prepare ground for the RA of CR&VS in Iraq; and agree on the timeline for the assessment finalization.

Based on the outcome of the above mentioned meeting, the assessment took place in Baghdad in a national workshop on 8-10 March 2011, after finalizing the draft the assessment report was shared with WHO on 31st of March 2011. WHO in turn technically revised this report and shared it back with the MoH for final revision. The final report was endorsed by H.E. the Minister of Health and WHO worked on the publication and dissemination of the findings of the final report. This report will be used as a basis for the development of the national HIS strategic plan.

It is worth mentioning that the report calls for identifying the pressing needs and implementing the most effective interventions to reform and strengthen the HIS and to prioritize and streamline the inflow of resources into the health care system.

The assessment has identified a number of issues, problems and gaps in the existing HIS. Each will be scrutinized from various perspectives in order to produce quality information in a timely manner and ensure their adequate use by all relevant stakeholders. Below table presents the assessment findings of the six HIS components.

Categories	Scores		Percentage (%)
	Maximum	Assessed	
1. Resources	75	33.5	Present but not adequate (45%)
2. Essential Health Indicators	15	10.0	Adequate (67%)
3. Data sources	228	135.5	Adequate (60%)
4. Data management	15	8.0	Adequate (53%)
5. Information products	207	151.0	Adequate (73%)
6. Dissemination and use	30	15.0	Adequate (50%)
Overall HIS	570	353.0	Adequate (62%)

The assessment report concluded that the NHIS in Iraq was assessed adequate (62%). This score is interpreted as weak NHIS. To serve its perceived objectives, the system needs to be reformed and strengthened. Therefore, it is recommended that the current assessment exercise should lead to developing a HIS Strategic Plan for Iraq, as soon as possible. The Strategic Plan should reflect the findings of this report and the above recommendations.

On another note and under the request of MoH, WHO organized a basic and advanced Geographic information System (GIS) training which took place from 5-15 April 2009 in Amman- Jordan at the Royal Scientific Society for 5 MoH staff working for the Central Health Information Department, 2 staff from each of the following DoHs: Basrah, Erbil, Muthanna and Missan.

In addition it is important to outline that as per the agreement with MOH, WHO supported the V SAT connectivity subscription fees for the Health Information System (HIS) last year under SPHCS phase I, and continued supporting the connectivity subscription fees for the year 2009.

Output 4: Sustainable Financing and Social Protection System of MoH Developed.

WHO was a major contributor to the International Scientific Conference of Health Research which was held in Baghdad from 12-15 December 2009. WHO contributed tremendously to the Health Economics, Health Administration and Health Financing sessions of this conference and contributed to the final recommendations for Iraq.

National Health Accounts and Health Expenditure Review:

The first National Health Account Report for Iraq has been published. The NHA is a powerful analytical tool used to assess health care financing function in health system. NHA will lay out solid foundations for government of Iraq to manage and sustain scarce resources in the health sector and provide basic information related to health financing needed to develop health care financing policies. The findings and conclusions of national health account analysis will have a great impact on shaping policy reforms in the field of health financing in Iraq. The first round of national health account that is finalized represents an excellent achievement of national health teams and represents a milestone in assessing health care financing in Iraq and in improving the overall health system performance in order to achieve the health system goals of improving health, reducing health inequalities, securing equity in financing and responding to the population's needs and expectations

The NHA exercise started in late 2004, under Strengthening Primary Health Care System Phase I project, but due to the deteriorating security situation especially in 2006 and 2007, and the change in Ministry of Health priorities of that time, it was decided to withhold the work on NHA. In 2009, the NHA was revitalized by WHO under the financial and technical support of Strengthening Primary Health Care phase II project. The field work took place in 2010, while the finalization and publication of the 1st round of National Health Accounts Report was completed in 2011.

The following main steps were taken in 2010 in order to support the implementation of the mentioned two exercises. A detailed NHA work plan was drafted; a multi-sectoral Steering Committee (SC) and Executive Committee teams for NHA were formulated and ToRs were drafted.

A national training for NHA team took place during 17-20 January 2010 in Baghdad. The aim of this training was to understand the context and reasons for the development of NHA methodology; be able to communicate the basic concept of NHA, what it attempts to measure, and its role as a tool for the policy process; and recognize the distinctions and similarities of various tools for measuring health expenditures. Finally, costing methodology manual for the BHSP in Iraq was drafted and a national training for the MoH officials on this manual took place in Baghdad in May 2010.

Based on the above proceedings a nationwide National Health Account (NHA) survey was launched by MoH with technical and financial support of WHO. The aim of this survey was to collect the needed information for the NHA exercise from the different stakeholders and thus to provide MOH with the best financing options which will serve as a critical input to the formulation of National Health Financing Strategy.

The data collection started in mid July 2010 and was completed by the end of August 2010. The data entry and analysis was completed by the end of November 2010. The survey included 16 district hospitals, 98 Main Primary Health Centers and 48 Sub Primary Health Care Centers, so all in all survey results were derived from 162 health facilities.

The work continued in 2011, where Iraq Country Office in collaboration with EMRO organized a three days training workshop on Health Care Financing (HCF) in Amman during the period of 27, 28 February- 1 March 2011. This training workshop aimed at finalizing the 1st NHA report for Iraq. During the above mentioned workshop the National NHA Steering Committee was trained on different topics of HCF. In order to enhance the hands on experience of the National NHA team, the team was assigned to use the real data during the group work

sessions as well as guidance was provided on how to populate the NHA matrices using the figures of Iraq. The aim of this practical exercise was to enhance the skills of the National NHA team on the use of software and thus institutionalize the capacity building efforts which will enable the National team to carry out the upcoming rounds of NHA with minimal or no external assistance.

After the above said workshop, the draft report was finalized by the Iraqi team, endorsed by H.E. the Minister of Health, edited, translated into Arabic, published and disseminated to all concerned parties, including MoH, WHO Regional and HQ Offices and other UN agencies.

The first attempt of this report shed some light on health care financing in Iraq and has provided some important findings. The level of health care spending, as per capita and as share of GDP, remains less than the average of countries with similar income. However the structure of health care financing shows a fair degree of equity in view of the limited burden on households who share only one fourth of the total health bill.

The high level of government contribution in health care financing reflects the constitutional commitment of the state to secure health and social security to individuals and families. Government through MoH is providing universal coverage by social health protection, which constitutes an important achievement of the Iraqi health care system.

In general, Iraqi health funds are primarily spent on curative care (more than 37%). A considerable share, 36.8%, goes towards pharmaceuticals dispensed for outpatient care, and 22.4% is spent on administration cost and salaries (Table 5, Figure 4).

FUNCTIONAL DISTRIBUTION OF HEALTH CARE EXPENDITURES, 2008

Function	Amount (ID)	Percentage	Per capita ID	Per capita US\$
Inpatient curative care	614 161 503 474	11.99	19353.95	16.54
Basic medical and diagnostic services	1 303 505 329 730	25.45	41053.06	35.09
Pharmaceuticals and other medical non-durables	1 885 500 625 470	36.81	59331.50	50.71
General government administration of health	1 147 085 680 919	22.39	35963.72	30.74
Health administration and health insurance: private	473 633 600	0.01	14.85	0.01
Health-related functions	171 947 747 017	3.36	5390.95	4.61
Total	5 122 674 520 210	100.00	161108.03	137.70

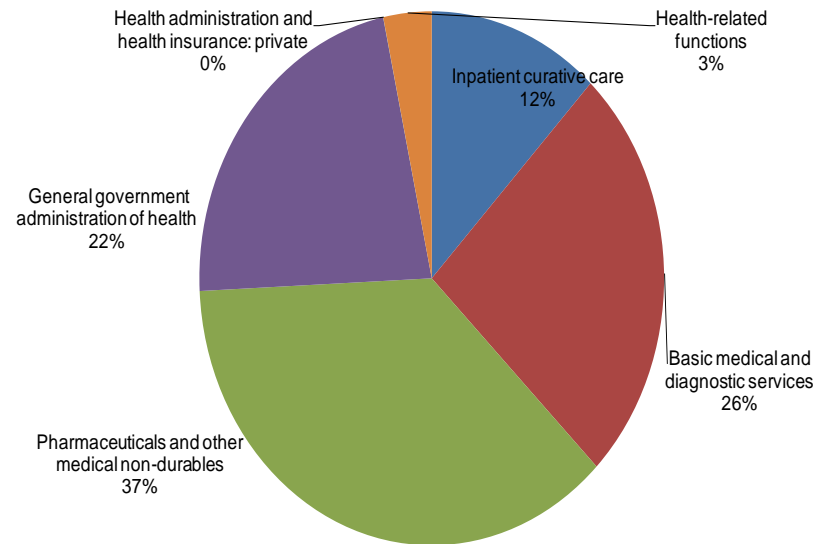

Classification by function

As mentioned above findings related to spending on major line items, show a relatively high share of total spending on health and bio-medical technology, similar to countries of middle income in the WHO Eastern Mediterranean Region. Total spending on medicines is shared almost equally between government and families, which highlights the importance of technology as an important cost center and as an area where efficiency savings are needed in terms of procurement system, appropriate selection and rational use.

The present structure of health care spending for both ministry of health and households does not allow a refined analysis of utilization of financial resources inside the health care system. However spending on health workforce, as a percentage of national budgets, remains lower than the average of countries of the region of similar level of income, despite a higher health workforce density.

Based on the preliminary analysis provided by the first national health account, the following recommendations are offered to the Ministry of Health and government officials.

- Secure ownership of the national health account exercise by internalizing it within the Ministry of Health set up, by coordinating the efforts with major stakeholders including the Ministry of Finance, planning and development cooperation, Central Organization for Statistics and Information Technology, private sector, etc. and by providing more training on national health accounts methodology.
- Ensure wide dissemination of the first national health account findings among health professionals, stakeholders, parliament, media and the public at large in order to increase knowledge and awareness about the health care financing function and its contribution to improving health system performance.

- Improve quality of data collected from various related ministries and agencies and initiate a better costing system and financial management inside the Ministry of Health. In order to improve data on household expenditures, it is recommended to implement a survey on dedicated household health expenditures and utilization with technical support from WHO and other partners.
- Promote a culture of costing and cost analysis in the health system in order to improve financial management and cost containment strategies.
- Make a case for investing in health by mobilizing additional resources from government budget, local government, taxation and communities in order to rationalize the use of free public services.
- Initiate feasibility studies related to the development of contributive systems of social and preventive health insurance, with technical support from WHO, International Labour Organisation and other development partners.
- Strive to improve the efficient use of public resources through better selection of technology, rational use and the development of a health technology assessment function.

Output 5: Enhanced MoH leadership and Governance.

5.1 Community Based Initiative

The goal of the community-based initiatives programme is to create development policies and directions that are supportive to health, community empowerment and local governance to ensure health equity and quality of life. The approach places health at the core of the development process and identifies ways to address disparities in the health care system and create equitable solutions for health care delivery. Through the programme community organization and mobilization is strengthened. The initiatives improve people's access to basic needs, such as nutrition, safe water, sanitation, shelter and access to preventive and curative health services.

The programme has been implemented in 17 countries of the EMRO Region including Iraq. The initiatives empower communities to assess, analyse and prioritize their development needs, based on available resources and generate additional resources to implement and monitor their own planned interventions.

As per the MoH request, WHO organized a study tour for the Community Based Initiative (CBI) Technical Committee to the Arab Syria Republic during the period of 15-18 August 2009. The objective of this tour was to 1) Share experience on implementation of Healthy Village Programme (HVP) in Syria and Basic Development Needs (BDN) Programme in Iraq 2) Have a better understanding of the existing community organizations and the role of Cluster Representatives and health volunteers in HVP 3) exchange experience on key elements of CBI sustainability including political commitment and how to maintain CBI as an integral part of the health agenda 4) Exchange knowledge in building partnerships for health development and mechanisms on inter-sectoral collaboration for health action 5) Conduct field visit to HVP Syria and also to health and social interventions provided by UN Relief Work Agency (UNRWA) to Palestinian Refugees in Damascus.

Eight CBI Technical Committee members from the Ministry of Health, Planning, Agriculture, Higher Education, Municipality, Construction, including representatives of Al Waqf Al Sunni and Al Waqf Al Sheie participated in the study tour.

By the end of this tour, the Iraqi team had a good exposure to the successful Syrian experience related to the different elements of the CBI programme, in addition the team was exposed to the long experience that UNRWA is having in community work within the Palestinian Refugee Camp in Damascus.

5.2 Millennium Development Goals (MDGs)

The United Nations Millennium Development Goals (MDGs) are eight goals that all 191 UN member states have agreed to try to achieve by the year 2015 including Iraq. In 2009, Iraq tailored the international MDGs to the Iraqi context, and a national MDGs Steering Committee was formulated, where the MoH was an integral part of this committee. In light of this and in order to further raise the capacities of MoH officials at central and governmental levels on MDGs WHO Iraq Office in collaboration with UN ESCWA organised a national training workshop in Erbil during the period of 6-10 February 2011 on (MDGs). This activity comes as a follow up to September 22-28/ 2010 training workshop, which was conducted for 20 Senior Leaders from the MoH and other line ministries at the Central and Southern Governorates, who met under WHO auspices in Beirut, for an intensive leadership development experience designed to strengthen the pursuit of MDGs for the people of Iraq. The February 2011 activity was initiated under the request of the MoH in order to cover the Northern Governorates needs to be trained on MDGs.

The training workshop objectives were to raise the awareness on the global MDGs and the national MDGs tailored for Iraq with a special focus on Health related MDGs. The main discussion focused on the current situation of Iraq with regard to health MDGs; strengthening Planning, Monitoring and Evaluation as well as reporting functions of the government officials, taking into account the National Development Plan and the Health Sector Strategy in addition to other related national strategies.

A total of 20 participants from both Central MoH in Baghdad and Central MoH in Erbil as well as from DoH in Erbil, Sulimanyia, Dohuk and Kirkuk. The private sector was represented in the mentioned workshop by the Head of the Dental Syndicate in Baghdad. By the end of this training workshop, the following was agreed as recommendations and way forward for MDGs: Advocate for formulation of an inter-sectoral committee for MDGs; Assign a focal point for MDGs at the central MoH in Erbil; Conduct National Training Activities in all the 3 governorates on MDGs; Alignment of Strategies, Plans with NDP, MoH Strategic Plan and MDGs for Iraq; Repeat the workshop for policy makers in the region; National awareness for MDGs in the media; Involvement of private sector and other line ministries in MDGs.

5.3 Social Determinants of Health

The social determinants of health are the conditions in which people are born, grow, live, work and age, including the health system. These circumstances are shaped by the distribution of money, power and resources at global, national and local levels, which are themselves influenced by policy choices. The social determinants of health are mostly responsible for health inequities - the unfair and avoidable differences in health status seen within and between countries.

Responding to increasing concern about these persisting and widening inequities, WHO- Iraq Organized on the 3rd of May 2011 a three-days training workshop on “Social Determinants of Health (SDH): Concepts and Tools to Promote Equity in Health in Iraq” was conducted in Amman to raise the profile of SDH and health equity in Iraq. In this connection, the workshop was initiated to build on the fact that health systems are themselves social determinants of health. The main objectives of the workshop were to identify the challenges to the achievement of health equity in a conflict setting, and to propose a Plan of Action and identify sustainable structures to address these issues. It is worth mentioning that incorporating Health in All Policies will assist leaders and policy-makers to integrate considerations of health, well-being and equity during the development, implementation and evaluation of policies and services. During the workshop, the participants from different ministries and syndicates including the Ministry of Health, Finance, Women Affairs, Defense, Labor and Social Affairs, Education, head of the Medical Syndicate and Head of the Nursing Syndicate were introduced to each other and had the opportunity to engage in group work to identify and prioritize six SDH and health inequities in Iraq and to work on a plan of action to put the multi-sectoral structure of SDH Steering and Technical Committees within the MoH.

5.4 Leadership and Strategic Planning

To date a total of 45 countries have developed/revised their National Health Strategic Plans showing an increase of 42% in the past 4 years. These plans are more comprehensive and are based on good situation analysis. In many countries these plans are the basis for harmonizing partnerships, ensuring alignment and facilitating coordination. They also contribute to strengthening country ownership and establishment of mutual accountability for results.

Hence, WHO in collaboration with John’s Hopkins University, organized a five days training workshop on Leadership and Strategic Planning in Istanbul-Turkey during the period of 23-27 May 2011.

The main objective of this training was to strengthen the capacity of the members of technical committees of the MoH responsible for updating the national MoH strategies on the strategic planning cycle, in order to equip them with the knowledge and skills needed to revise and update the Health Sector Strategic Plan for 2008-2013. This training is considered as an initial step towards revising the PHC part of the mentioned strategy, where WHO technical assistance was requested earlier by the Ministry of Health.

The delegation was headed by the Deputy Director General for Planning and Resource Development from Baghdad MoH and Director General of Planning from MoH of KRG. It is worth pointing out that representatives of planning departments of most governorates i.e. Karbalaa, Najaf, Salah El Dean, Basra, Wassit, Diala, Anbar, Babil, Mousel, Sulymania as well as Baghdad took part in the mentioned training. By the end of this training workshop, a set of recommendations was agreed among all participants on the way forward for revising the Health Sector Strategic Plan (2008-2013) in both the Central Ministry and KRG Ministry of Health.

5.5 Mental Health

Mental illness is particularly important because its burden is often underestimated. It remains a stigma and has detrimental effects on the person and society. According to Iraqi Mental health survey 2007, although 35% of Iraqi people are suffering from distress and 16% had at least one mental illness during their life span, mental services is provided to 2.2% of mentally ill people. Due to the above facts, public awareness and early intervention at the very first level of care become increasingly essential.

Raising awareness of the PHC workers on the role of mental health as a basic foundation to achieve general health for the person himself and his family, and the possibility of prevention of mental disorders was one of the main objectives that was achieved during the implementation of this programme; as well as raising knowledge in mental health situation and mental disorders.

Improving skills of the PHC health workers to provide proper mental health services for the needy people was the ultimate goal of this project. A total of 57 National Training Activities (NTAs), three NTAs for each directorate of health, 4-days each, for general practitioners and nurses at primary health care level has been conducted successfully as per the agreed action plan. A total of 1685 health professionals have been trained, out of which 1218 were male participants and 467 were female participants. These trainings covered all the 19 governorates with an average participation of 25-30 trainees in each session and will make sure that mental health services are provided under the umbrella approach of primary health care.

This capacity building programme was initiated in a Training of Trainers (ToT) workshop organized in April 2011 in Erbil, with the objectives to: revise WHO mental health training modules and produce a standardized training package adopted to the context of Iraq; assess the current situation of mental health in Iraq; identify the suitable WHO national mental health manuals to be used for training PHC health workers.

This workshop was followed by another ToT in Erbil in May 2011, where the training modules that were used as the training material for the 57 NTAs were updated, finalized and adopted as the formal curriculum, in addition trainers were oriented on those modules and action plan for NTAs implementation was also agreed.

The Iraqi Ministry of Health and the Ministry of Health of the Kurdistan Regional Government, in collaboration with the World Health Organization, conducted a workshop in Erbil on 27-29 February 2012 to review the above mentioned 57 NTAs carried out in the governorates throughout 2011, and to exchange experiences and lessons learned in implementing mental health in primary healthcare services.

WHO mental health training modules were finalized in May 2011, have been adopted by Iraq. It is worth to mention that WHO has so far helped training a total of 1,685 health professionals, of whom 1,218 were male and 467 female, through 57 four-day national training sessions.

5.6 Advanced Managerial Skills

The Government of Iraq has requested the World Health Organization to support the MOH/Iraq in building the capacity of Iraqi professionals in the area of advanced managerial skills. As part of an agreement done by the Ministry of Health in Iraq and World Health Organization Office Iraq to strengthen the health management skills of a core group of health professionals, the leadership of Ministry of Health and WHO office for Iraq are pleased to embark on this initiative. This program aimed to strengthen the skills of the decision makers in strategic planning, health care financing, hospital reform, decentralization and change management. The advanced knowledge in the mentioned areas will enable this core team of health professionals to carry out the evidence based analysis of organizational and institutional functioning and governance in order to streamline service delivery structures, procedures and decision-making as part of the overall modernization efforts ... etc.

It is expected that by the end of the Program, the participants will be able to:

- Speak a common language about dimensions of health sector reform and sustainable development;
- Analyze organizational and institutional functioning and governance towards streamlining service delivery structures, procedures and decision-making;
- Analyze how to select and apply tools and procedures to make desired changes that would affect image and utilization of health services in facilities;
- Draft a strategic plan that would provide directions to improve the planning, development, delivery and evaluation of health programs and services;
- Prepare evidence based policy briefs to decision makers.

This Program consisted of nine modules whose content were adapted to reflect the needs of Iraq and the plans to reform the Iraqi public sector. Each module was covered over five days and conducted jointly by two faculty members (lead and co-facilitator) from FHS or affiliated resource persons with experience in adult learning. All training activities featured interactive training techniques as well as emphasis on practical application skills that incorporate both adult learning pedagogy and material specifically tailored to the needed technical medical skills. Furthermore, the content had exercises and case studies adapted to reflect the health sector in Iraq and some others from the Middle East and other regions as appropriate. The first two modules were conducted in November 2011, another 4 modules were in December and February, while in March one module was finalized and by the end of April 2012, the 9 modules were successfully delivered..

Twenty health care managers and decision makers, representing different senior departments at the Ministry of Health in Iraq and Ministry of Health KRG Iraq, received their diplomas in advanced health managerial skills from the American University of Beirut (AUB) on 20 April 2012, as part of a capacity-building programme by the Ministry of Health and WHO.

The six-month diploma programme consisted of nine five-day modules, whose contents were adapted to reflect the needs of Iraq and the plans to reform the Iraqi health sector. The modules were taught jointly by two faculty members with experience in adult learning and aimed to strengthen the skills of a core group of health professionals in strategic planning, health care financing, hospital reform, decentralization and change

They were designed to enable the participants to carry out evidence-based analysis of organizational and institutional functioning and governance, and to streamline service delivery structures, procedures and decision-making as part of the overall modernization efforts in Iraq. All training activities featured interactive training techniques, as well as an emphasis on practical application skills that incorporate both adult learning pedagogy and material specifically tailored to the needed technical and managerial skills. Furthermore, the training featured exercises and case studies adapted to reflect the health sector in Iraq.

The 20 trained health professionals with advanced knowledge in management, especially in strategic planning, will form a core team that will assist the various departments of the Ministry of Health in the development of the National Health Policy and the revision of the National Health Strategy. They will ensure that new policies, strategies and plans are based on evidence and the realities on the ground. They are also expected to contribute to strengthening the governance and leadership role of the Ministry of Health at the national and governorate levels.

5.7 Strengthening Management and Administration Skills for Office Managers.

A one week training workshop was organized in Istanbul-Turkey from 13-17 May 2012 in order to strengthen the management and administration skills of 30 office managers working for the Offices of H.E. the Minister of Health, Deputy Minister and Director General Offices at governorate levels.

A large array of technical workshops has been organized by WHO Country Office of Iraq under the leadership of the Ministry of Health with involvement of other relevant ministries as well as professional bodies, syndicates representing private sector. The prime aim of these technical workshops was to strengthen the capacity of government in all six health system building blocks as stressed by the WHO health system conceptual framework i.e. governance and leadership, service delivery, health information system, health care financing, health technologies and pharmaceuticals and human resource.

It was realized soon that only building the capacity of technical departments will not lead us to tangible outcomes, in order to reach to our objectives of improved health and enhanced responsiveness of health system, it is equally important to consider building the capacity of support departments, especially in the area of advanced management and administration. Thus, WHO- Iraq Country Office in collaboration with MoH embarked on the mentioned one week workshop which will help to equip the senior level office managers with advanced knowledge in management and administration, so that they are better able to respond to the changes provoked by the advances in technology and information in conformity with the requirement of their current working set up.

A strong satisfaction has been echoed by all participants of the workshop as well as strong commitment was demonstrated by the head of offices to bring innovative changes in their work setting on their return from this workshop. In addition, strong reassurance was shown by all participants to train other officials of the concerned office on the new skills and advanced knowledge which has been acquired during this 5-days workshop.

This 5 –days training provided an unprecedented opportunity for senior level office managers to interact, exchange their experiences, share their challenges, establish network and find solutions for their problems of mostly common nature in a very friendly and team oriented approach.

The Office managers of H.E. the Senior Deputy Minister of Health, the Minister's Deputy for Administrative Affairs, the General Inspector Office, Medical Operations, Kemedi, Medical City, as well as the office managers of Directorate of Health from Baghdad, Diala, Thi Qar, Karbala, Najf, Muthanna, Anbar, Duhuk and Erbil, appreciated this joint initiative of WHO and Ministry of Health which enabled them to get to know about the problems and challenges being faced in various offices at other line departments and at the governorate.

Summary of Capacity building activities supported by Primary Health Care Phase II project:

Institutional development including capacity building of Human Resources for Health has been identified as one of the main priority area which has to be considered by partners working in health sector. In these lines a large array of capacity building activities have been carried out by WHO Iraq office to strengthen the various building blocks of health system and mainstream the principles of PHC in all initiatives especially related to health services delivery. During the last four years of PHC phase II project around 5,000 health professionals have been trained in technical areas related to all the 6 building blocks of health system. Out of this total number 2507 were male health professionals and 1095 were female health professional from all levels of health system. 88% of all these capacity building activities were convened inside Iraq and the remaining 12 % took place in countries of the region.

- **Qualitative assessment:**

Under this project WHO has contributed to the Government of Iraq initiative of ‘Modernizing the Health Sector’. The modernization initiatives that were taken under this project started by developing the ‘Basic Health Service Package’ that was considered by MoH as the corner stone for the health sector modernization.

The implementation of this package started also under this project through Integrated District Health System based on Family Practice Approach (IDHS-FPA). The continuous effort in building national capacities was one of the major tasks under this area of work in order to upgrade the national knowledge and capacities.

Another crucial part of the health sector modernization that was supported by this project was the development of the key health sector strategies i.e. Human Resources for Health Strategy and Health Information Strategy. It is worth to mention that the processes for developing the strategies were initiated under this project by developing and/or updating the regional and international assessment tools and adapting it to the Iraqi context, building the national capacities conducting assessment for the current situation and producing assessment reports that were endorsed by H.E. the Minister of Health. These reports will act as the major inputs to the mentioned strategies development process and it is imperative to outline that both the strategies will be developed with the support of Iraq Public Sector Modernization Project a UNDG-ITF supported project..

Producing the first NHA report was another important area of work that was implemented under this project. As this was the first ever NHA report that Iraq has produced and published with the technical and financial assistance of WHO. The process to reach this end result included enormous efforts of building the national capacities with the support of International consultants, WHO regional and HQ expertise.

Modernizing the health system needs enormous efforts of building the national capacities in different strategic areas of work. By the end of this project and over the last four years, WHO managed to train around 5,000 people from its national counter parts from MoH and other ministries, local community, medical syndicates and civil society.

In conclusion it is worth to note that the various strategies, guidelines which were developed with the support of this project will lay the foundation for successful reform of the health system which will be able to provide equitable access to quality health services to all population of Iraq.

Programme Title:	Strengthening of PHC system in Iraq phase 2						
NDS/ICI priority/ goal(s):	<p>NDS Strengthen the national healthcare delivery system, and to reorient it from being hospital-focused to being based on Primary Health Care delivery.</p> <p>Strengthen emergency preparedness and response in order to address the needs of Iraqis, especially vulnerable populations, while promoting a healthy living environment</p> <p>ICI Protecting the poor and vulnerable groups from the deprivation and starvation and provide the Iraqi citizens with proper standards of public social services</p>						
UNCT Outcome	Improved performance of the Iraqi health system and equal access to services, with special emphasis on vulnerable, marginalized, and excluded.						
Sector Outcome	By 2010, health and nutrition related programmes enhanced to ensure 20% increase in access to quality health care services with special focus on vulnerable group.						
IP Outcome 1	Enhanced access to and delivery of integrated equitable sustainable quality health service			NDS / ICI Priorities: 4.4.1.4(Health)			
IP Outputs	UN Agency Specific Output	UN Agency	Partner	Indicators	Source of Data	Baseline Data	Indicator Target
IP Output 1.1: Capacity of Ministry of Health in target areas developed for improved integrated health delivery services	FM and IMCI program expanded for enhanced integrated health service delivery	WHO	MoH/ DoH/ MoHE	Number of FM clinics rehabilitated Number of clinics implementing IMCI	WHO report/ MoH reports	3 clinics are currently rehabilitated and implementing IMCI	8 clinics (3+5) to be rehabilitated and implementing IMCI
	Ministry of Health supported to undertake the development and implementation of referral policies at national level	WHO	MoH/ DoH	Referral policy developed MoH adopts and implements referral policy	WHO report/ MoH reports	No policy is available	National referral policy in place
	Improved capacity of MoH at the national level in the area of health system research (specific areas of research will be identified based on need)	WHO	MoH/ DoH	5 health system researches completed	Project reports Research reports	0	5

	MOH supported to integrate MH services into PHC system	WHO	MoH/ DoH	Number of Nurses and GPs trained on delivery of mental Health services (gender disaggregated) % of trainees passing the individual skills evaluation Guidelines for mental health service delivery developed	Training reports	0 Pretest results guidelines are not available	75 GPs and nurses trained 100% of trainees Guidelines for mental health service delivery in place
	Ministry of health supported to construct 15 PHCs in selected governorates	UNICEF	MoH/ DoH	15 new PHCs constructed in selected governorates		0	12 PHCs constructed
	Improved capacity of community-based psychosocial support structures	UNICEF	MoH/ NGO partners	Number of community volunteers trained % of community volunteers passing the individual skills evaluation	Project progress report Training report Pre-post tests results	0	200 community volunteers trained on Psychosocial support 100% of the Community volunteers passing the individual skills evaluation
IP Output 1.2:	Enhanced capacity of MoH to undertake sound human resources planning	WHO	MoH/ DoH/ MoHE	Guidelines on human resources planning is developed	Project report MOH / WHO records	0	1
	Enhanced ability of MOH on Human resources planning	UNICEF	MoH/ DoH	Number of health staff trained on delivering basic health services package (gender disaggregated) % of health staff passing the individual skills evaluation	Project progress reports	Training of 750 MOH staff ongoing	1,500 (750+ 750) will be trained on delivering basic health services package

					Pre and post tests results	Pre-test results	100% of the Community volunteers passing the individual skills evaluation
IP output 1.3 National Health Management information system strengthened	Strengthened institutional capacity of MOH at national level to manage national health information systems	WHO	MoH/ DoH	No of staff trained on managing health Information systems 9 gender disaggregated) % of trainees passing the individual skills evaluation	WHO Reports	0	15
					Pre-post tests results	Pre-test results	100% of health staff trained passing the individual skills evaluation
	MoH supported to develop and implement 10 emergency sentinel surveillance system in selected governorates	WHO	MoH/ DoH	Surveillance system set up in 10 more governorates	MoH records WHO progress report	3 governorates	13 (3+10) governorates implementing emergency sentinel surveillance system
	MoH supported to expand VSAT connectivity to the district level	WHO	MoH/ DoH	Number of districts connected through VSAT with MoH	MoH records WHO progress report	19 DoHs	19 DoHs and 19 Districts
IP output 1.4 Sustainable financing and social protection system for MoH developed	Ministry of Health is supported for the revitalization of the national health accounts program	WHO	MoH/ MoP/ DoH	National accounts program is implemented by MoH <i>Further indicators pending programme implementation</i>	MoH records WHO progress report	0	National accounts program is implemented by MoH
	Basic health service package piloted in 5 selected governorates	WHO	MoH/ DoH	Number of governorates with trained staff to implement Basic Health Service package <i>Further indicators pending</i>	MoH reports WHO progress report	0	5 governorates implementing Basic Health Service package

				<i>programme implementation</i>			
	Ministry of health is supported to develop a healthcare financing policy	WHO	MoH/ MoP/ MoF/ Parliament	Policy document on health care financing policy developed	MoH reports WHO progress report	A health care financing policy is not available	Policy document developed
	Ministry of Health supported to develop a National Health Insurance policy	WHO/ HNSO T	MoH/ MoP/ MoF/ Parliament	Health Insurance policy document submitted to MoH for approval	MoH / WHO reports	No policy health insurance policy is available	Health Insurance policy document approved
IP output 1.5 Enhanced MoH Leadership and Governance for	Ministry of Health supported to develop a national health strategy (5 years)	WHO/ HNSO T	MoH/ Parliament	National Health strategy developed	MoH / WHO reports	No strategy is available	5 years National Health strategy in place
	Enhanced national capacity to develop and National inter-sectoral action framework for health focusing on community development	WHO/ SOTs	MoH/ Civil Society	Inter-sectoral framework on community development and submitted to MoH for approval	MoH / WHO reports	No Inter-sectoral framework on community	Inter-sectoral framework on community development approved by MoH
	National MDG forum developed to monitor progress of health indicators	WHO/ SOTs	MoH/ Parliament/ MoHE/ MoEv/ MoP/Mo Water resources /MoE	Multi sectoral MDG Forum is available Progress reports on health indicators	MoH / WHO reports Forum meeting minutes and progress reports	No forum is in place No reports are available	An MDG forum is in place Regular progress reports (quarterly)
	Ministry of Health supported to set up coordination mechanisms on mental health and psychosocial support within MOH central and governorate level	UNICEF/ WHO	MoH/ MOLSA	Number of coordination meetings	MoH / WHO reports Minutes of coordination meetings	No coordination mechanism in place	Coordination mechanisms on mental health and psychosocial support between central and governorate levels is in place

	structures			A national coordination mechanism in place	between central and district levels of MoH Official TOR for national coordination mechanism		
--	------------	--	--	--	--	--	--

iii) Evaluation, Best Practices and Lessons Learned

- The following were recognized as some of the pressing challenges which affected the implementation of the project outputs and which caused delay in the delivery of the agreed upon activities.
- The worsening security situation in most governorates of Iraq and as a result the movement restrictions posed constraints in the delivery of project outputs.
- The rapid turnover of staff especially the Heads of Technical Departments of MOH affected the continuity of some strategic level initiatives and thus caused delay in the completion and timely implementation of those initiatives.
- The lengthy bureaucratic procedures especially in relation to rehabilitation of infrastructure caused delay in the completion of the rehabilitation of the several PHC centers which were rehabilitated under this project.
- The nominations of different health professionals and sometimes the irrelevant professionals to the various technical foras in most instances made the follow up of various technical initiatives quite challenging and this break in continuity affected the pace of implementation of some project activities.
- So far no evaluation of the project has been conducted however rigorous monitoring for different project activities at various levels has taken place successfully.

Mitigation Strategies:

Despite the enormous challenges Iraq health system has shown high resilience during the difficult years of wars and post conflict period and has tried to address the challenges in an effective way. The MOH with the technical support of WHO and other partners has come up with number of effective strategies to mitigate the negative implication of the shortfalls in the various domains of health system.

Most of the mentioned constraints and delays were addressed by careful implementation of the following interventions:

- Focal points from Ministry of Health and other line Ministries were assigned for different project activities which facilitated the implementation and monitoring of the various project activities.
- The delay in rehabilitation of the Primary Health Care facilities was addressed by the recruitment of international Engineer who was supported by other projects of WHO. The active follow up by the expert made the implantation as planned with some delays.
- To expedite the implementation and make the various technical deliverable various short term experts were assigned to undertake specific project related technical assignments. The free movement of these short term experts to various governorates facilitated the implantation of various activities as well as fostered the collaboration with other partners especially at sub-national level.
- The inability to conduct meetings in some of the governorates due to worsening security situation and thus movement ban was addressed by organizing the meetings and workshop in alternated places either within the country or some countries of the region with flexible logistics and visa requirements.

Lessons Learned:

- This project though entitled Primary Health Care Project contributed to strengthening all the building blocks of Iraqi Health System including rehabilitation of infrastructure. Below are summary of some of the lessons which could be considered during the design of any future development project aiming to improve health system.
- A clear management and implementation structure and assignment of the project focal points who will monitor the implementation progress of the project played a key role in the successful accomplishment of the project objectives despite movement restrictions and security concerns.
- The financial and technical support provided by this project played a catalytic role in the initiation of change and facilitated the implementation of many reform elements e.g. development and implementation of Basic Health Service Package.
- The evidence generated by various policy level debates and documents entrusted a high level of interest which facilitated the development of a number of other evidence based interventions aiming to improve the various aspects of health system. For instance the first round of National Health Account which was conducted under this project prepared the ground to conduct the 2nd round of National Health Account which is underway currently and is financially supported by the Government of Iraq.

Abbreviations and Acronyms

GoI: Government of Iraq

MoH: Ministry of Health

MoE: Ministry of Education

MoHE: Ministry of Higher Education

MoA: Ministry of Agriculture

MoEn: Ministry of Environment

MoPDC: Ministry of Planning and Development Corporation

MoF: Ministry of Finance

MoHR: Ministry of Human Rights

MOHK: Ministry of Health in Kurdistan

DoH: Directorate of Health

COSIT: Central Organization for Statistics and Information Technology

SPHCS: Strengthening Primary Health Care System

PHC: Primary Health Care

PHCC: Primary Health Care Centers

CD: Communicable Diseases

EPI: Expanded Programme on Immunization

NCD: Non Communicable Diseases

CBI: Community Based Initiative

BDN: Basic Development Needs

HIS: Health Information System

HAC: Health Action in Crisis

AOSHC: Action Oriented School Health Curriculum

IMCI: Integrated Management of Childhood Illnesses

NDQCL: National Drug Quality Control Lab
BHSP: Basic Health Service Package
CCCU: Community Child Care Units
MDGs: Millennium Development Goals
IFHS: Iraq Family Health Survey
MICS: Multi Indicator Cluster Survey
UNCT: UN Country Team
IRFFI: International Reconstruction Facility Fund for Iraq
SOT: Sector Outcome Team
ICI: International Compact with Iraq
NGO: Non- Governmental Organizations
INGO: International Non- Governmental Organization
WB: World Bank
WHO: World Health Organization
UNICEF: United Nation Children's Fund
UNFPA: United Nations Population Fund
WFP: World Food Programme
UNOPS: United Nations Office for Project Services
UNIDO: United Nations Industrial Development Organization
UNDP: United Nations Development Programme